

# MISTRAL



evo



Ponti e Salvaspazio

## Indice composizioni

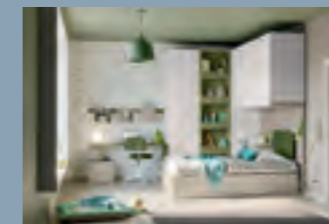

30 — pag. 006



31 — pag. 016



32 — pag. 026



33 — pag. 036



34 — pag. 044

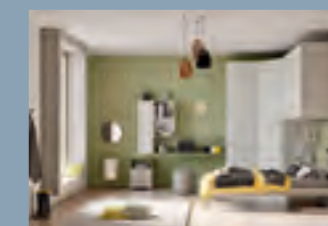

35 — pag. 054



36 — pag. 064

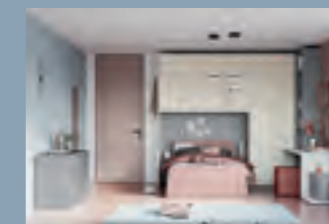

37 — pag. 074



38 — pag. 084

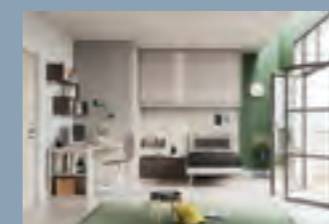

39 — pag. 094



40 — pag. 104



41 — pag. 112



41 var. — pag. 121



42 — pag. 128

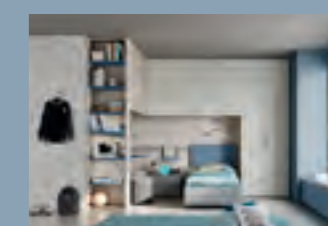

43 — pag. 138



44 — pag. 146

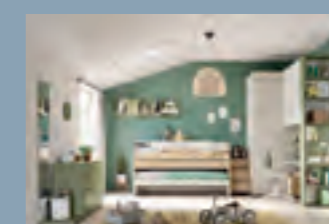

45 — pag. 156



46 — pag. 164

## Indice composizioni

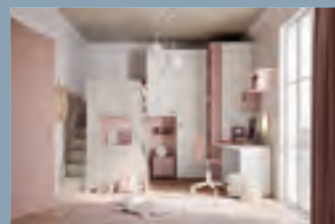

47 — pag. 174



48 — pag. 184



49 — pag. 194



50 — pag. 202

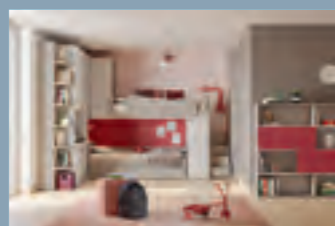

51 — pag. 214



52 — pag. 224



53 — pag. 232



54 — pag. 244



55 — pag. 254



56 — pag. 262



57 — pag. 270

# MISTRAL

## Ponti e Salvaspazio

L'evoluzione  
degli ambienti ragazzi  
*The evolution of children's  
environments*

p. 002

Ponti  
*Bridge solutions*

p. 004

Salvaspazio  
*Space-saving solutions*

p. 154

Inserti  
*Inserts*

Letti Hydro  
*Hydro sofa bed*  
p. 028

Letti Polar  
*Polar bed*  
p. 168

Scrittoi sospesi  
*Suspended desk*  
p. 060

Cabina Flexy  
*Flexi walk-in closet*  
p. 246

Letti a castello Zoom  
*Zoom bunk bed*  
p. 258

Finiture, maniglie,  
carte da parati  
*Finishes, handles,  
wallpapers*

p. 274

evo

# L'evoluzione degli ambienti per ragazzi

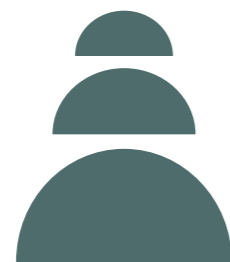

a tutte le età



valorizzare gli spazi

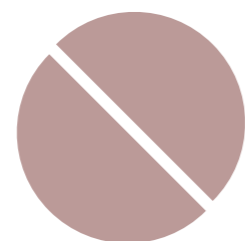

per lui e per lei

## Mistral EVO

Mistral si propone di progettare ambienti per ragazzi rispondendo a diverse esigenze di vita. Particolare attenzione viene data allo spazio gioco e divertimento che si trasforma in un multi-spazio dedicato allo studio e alle attività ricreative per i più grandi, ma anche per accompagnare i più piccoli nella loro crescita e in ogni momento della giornata.

L'area studio è proposta in diverse soluzioni pratiche e adatte a tutti gli spazi disponibili. Anche il guardaroba e i complementi fanno delle camerette Mistral una soluzione versatile e ideale ad ogni metratura.

Mistral disegna quindi soluzioni adatte a tutte le età, bambini e bambine, ragazzi e ragazze. Con la vostra casa si sposteranno perfettamente perchè il gusto accontenta tutti gli stili. Grazie alla varietà di componenti proposti tutte le camerette possono essere modificate nel tempo e riadattate alle necessità, sia di utilizzo che di spazio.



# Ponti

Le camerette Mistral sono caratterizzate da una nuova gamma di finiture: melaminici di base, melaminici colorati e tessuti, combinabili tra loro per creare infinite soluzioni per bambini di tutte le età. Le soluzioni Ponte esprimono un contenimento elevato dove l'armadio trova poca espressione a terra.

*Mistral bedrooms are characterized by a new range of finishes: wood melamine, colored melamine and fabrics, which can be combined together to create infinite solutions for children of all ages. The bridge solutions express a high containment where the wardrobe finds little expression on the ground.*





La zona studio si compone di elementi accostabili e sovrapponibili in funzione allo spazio.

*The study area is made up of elements placed side by side and superimposed, modular according to the space.*



Zona studio composta da scrittoio tipo 50 in appoggio a cassetiera a terra, barra Surf portaoggetti attrezzata di mensola in metallo laccato, e accessori portaoggetti, sedia Party imbottita.

*Study area made up of "50" desk over a chest of drawer, Surf bar with lacquered metal shelf, wall units, upholstered Party chair.*





Vista frontale della zona letto con comodino e barra Surf attrezzata di mensola in metallo e testiera letto imbottita.

*Front view of sleeping area with night table and Surf bar equipped with metal shelf and upholstered bed headboard.*





Giroletto alto 32 cm in dekor Canapa  
contenitore con rete rialzabile verticale.

Bed frame 32 cm high in Canapa dekor  
with bed base lift-up mechanism.



Cabina angolo Covert attrezzata internamente di ripiani, tubi appendi abiti e illuminazione.

*Covert dressing closet equipped with shelves, hangers and lighting.*



ambiente 10,5 mq



lui / lei

# 30

- A – Letto contenitore con rete da 120cm
- B – Ponte a terra con ante battenti
- C – Cabina Covert 181
- D – Scrivitoio tipo 50, L150cm
- E – Barra Surf

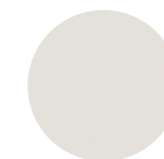

seta



dekor canapa



tortora



salvia

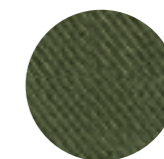

in&out S071





Vista frontale zona letto composta da armadio Mega, ponte con ante battenti, letto Artiko estraibile e terminale Free con ripiani, appendiabiti, seduta e cestone su ruote.

*Front view of sleeping area made up of Mega wardrobe, hinged door bridge, Artiko Estraibile bed and Free terminal with shelves, hangers, a sitting shelf and basket on wheels.*





Armadio Mega in profondità 105cm attrezzato internamente di ripiani, tubi appendiabiti e illuminazione.

Mega wardrobe in 105cm depth equipped with shelves, hangers and lighting.

La libreria Madison risolve con un'estetica accattivante il bisogno di contenere senza nascondere.

*The Madison library solve, with an appealing aesthetic, the need to contain without hiding.*



Libreria Madison a parete in dekor Bronzo e Canapa e ripiani in melaminico Rovere, scrittoio Isola con cassetto, casellario portaoggetti e pouf.

*Madison bookcase fixed to the wall in Canapa and Bronzo dekor and shelves in Rovere melamine, Isola desk with drawer, wall unit and upholstered pouf.*



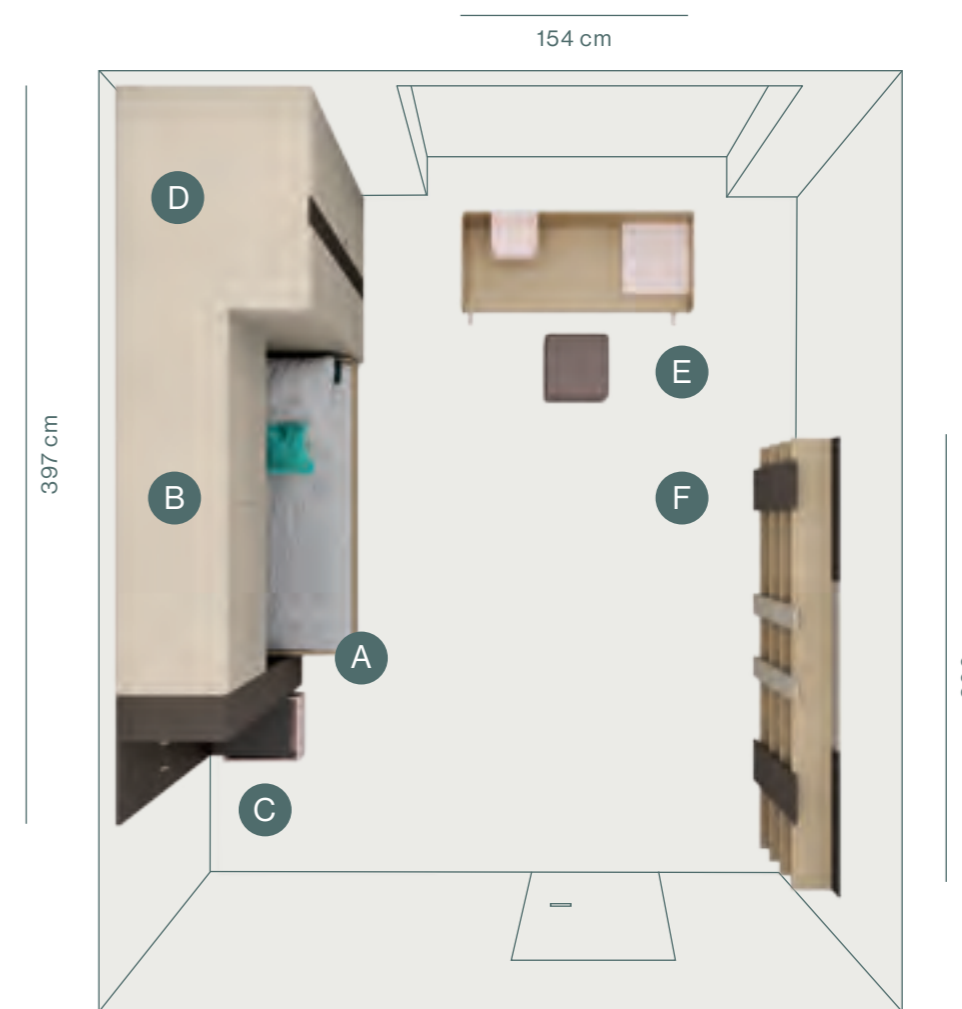

ambiente 15 mq

# 31

- A – Letto Artiko Estraibile con rete da 90cm
- B – Ponte a terra con ante battenti
- C – Terminale Free
- D – Armadio Mega
- E – Scrivania Isola L150cm
- F – Libreria Madison



rovere

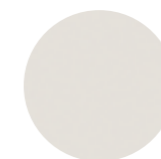

seta  
(struttura)



dekor canapa



bronzo

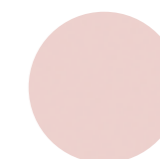

confetto







Divano letto Hidro con rete da 120cm attrezzato di vano a giorno uso comodino e cassettoni estraibili su guide. Dettaglio lampada portatile ricaricabile con cavo USB.

*Hidro sofa bed with bed base in 120cm depth, equipped with opened compartment and drawer on tracks. Detail of portable lamp with charging USB cable.*



## Divani Letto Hidro



A1

Divano letto Hidro con cassettoni su ruote.

*Hidro sofa bed with drawers on wheels.*



A2

Divano letto Hidro con rete estraibile.

*Hidro sofa bed with movable bed base.*



A3

Divano letto Hidro con contenitore e meccanismo per rete rialzabile orizzontale.

*Hidro sofa bed with container and bed base lift-up mechanism.*

## Divano letto Hidro



Il divano letto Hidro è configurabile con diversi accessori a seconda dell'utilizzo.

*Hidro sofa bed is customizable with different accessories according to the specific use.*





La tecnologia  
diventa parte integrante  
della cameretta.

*Technology  
becomes an integral part  
of the bedroom.*

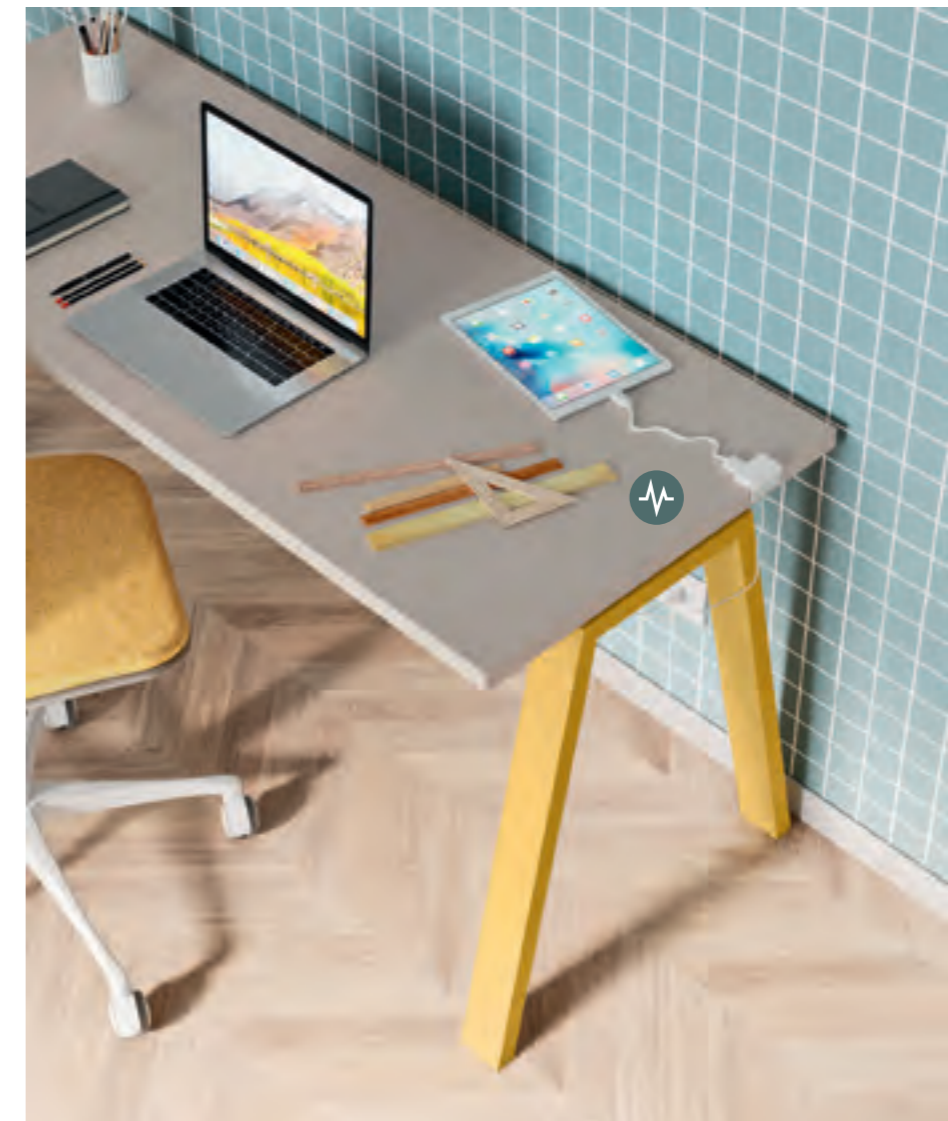

new  
technology

Scrivania tipo 50 in melaminico Tortora con gambe Fado laccate Curcuma, completo di accessorio ricarica USB, sedia Ekipe imbottita su ruote.

*"50" desk in Tortora melamine with Fado legs in Curcuma lacquered finish, with USB socket, Ekipe chair with wheels.*



Armadio battente attrezzato internamente di ripiani, cesto in metallo estraibile e appendiabiti. Maniglia T76 laccata Tortora.

*Hinged wardrobe equipped with shelves, movable basket and hangers. T76 handle in tortora lacquer finish.*





Terminale armadio free attrezzato di appendiabiti, ripiani e specchio.

*Wardrobe terminal free equipped with hangers, shelves and mirror.*

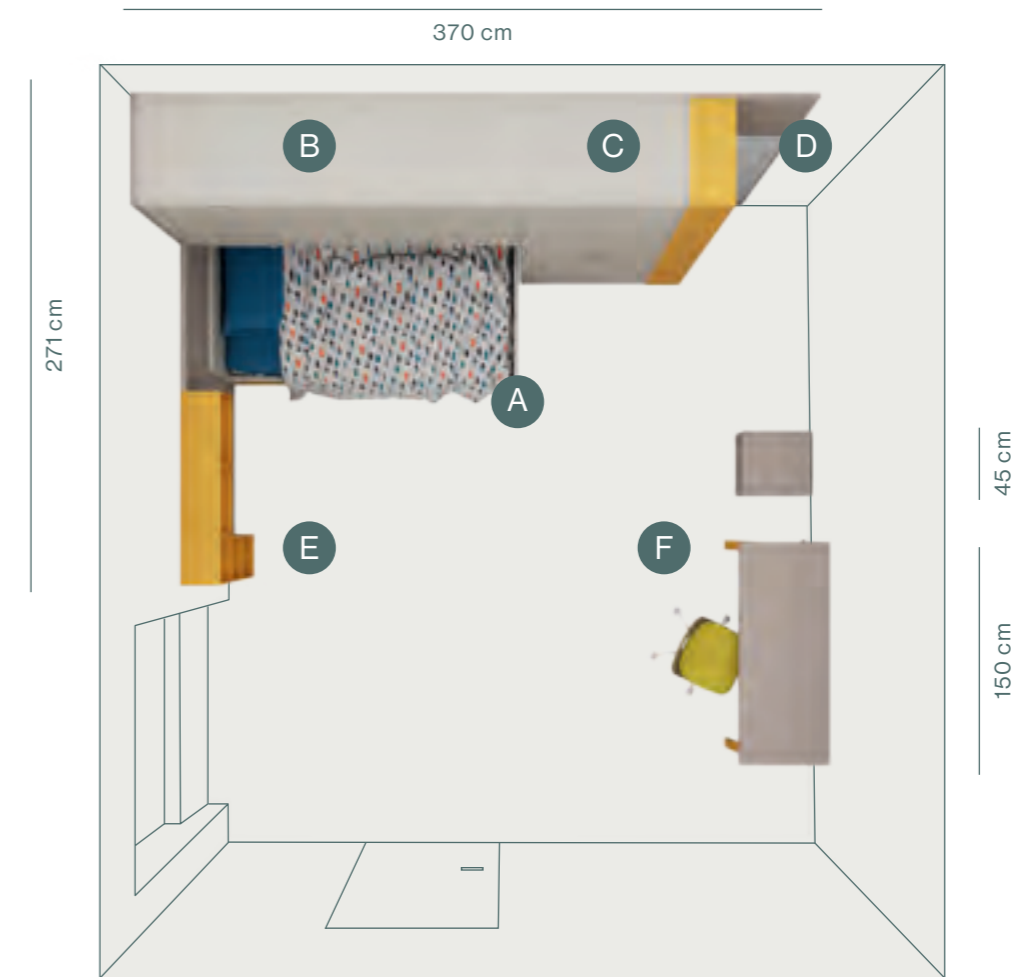

ambiente 10.5 mq



a tutte le età

# 32

- A – Divano letto Hidro con rete da 120cm
- B – Ponte a terra con ante battenti
- C – Armadio con maniglia T77
- D – Terminale Free
- E – Casellari Qubo
- F – Scrivitoio tipo 50, L150cm

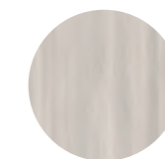

olmo chiaro



tortora



curcuma





Zona studio composta da scrittoio tipo 51, casellari Gregg, sedia Ekipe su ruote e cassetiera a tre cassetti.

Study area made up of "51" desk, Gregg wall unit, Ekipe chair with wheels and ground unit with three drawers.



La colonna Duplo risolve l'angolo con una botola dove poter nascondere oggetti di uso poco frequente.

*The Duplo wardrobe solves the corner with a trap door where you can hide infrequently used objects.*



Colonna Duplo con contenitore retroletto, divano letto One con rete estraibile in melaminico Olmo sbiancato.

*Duplo wardrobe with backbed container, One sofa bed with movable bed base in Olmo sbiancato melamine.*



apribile







Terminale libreria Free con ripiani,  
piano consolle e specchio.

Free wardrobe terminal with shelves,  
console and mirror.

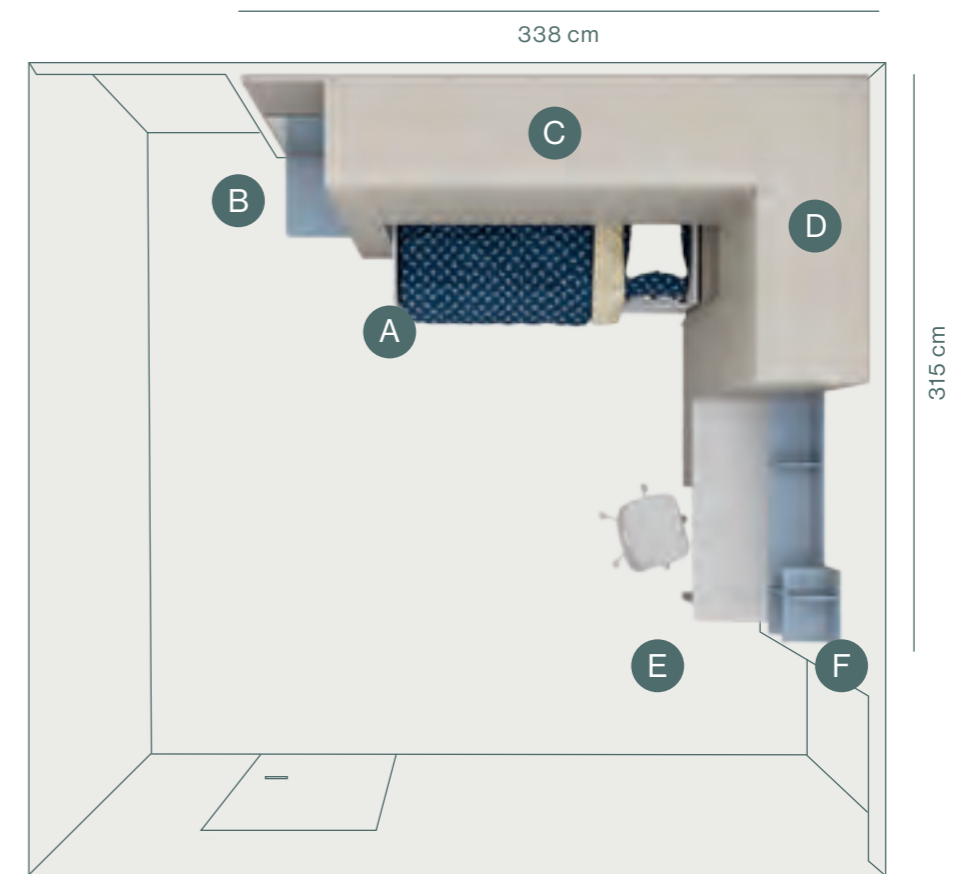

ambiente 12 mq



salvaspazio

# 33

- A – Divano letto One con rete da 90cm
- B – Terminale Free
- C – Ponte a terra con ante battenti
- D – Colonna angolo Duplo
- E – Scrivitoio tipo 50, L150cm
- F – Casellari Gregg

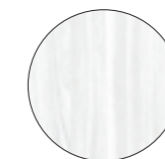

olmo sbiancato



dekor canapa

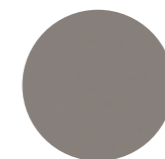

platino

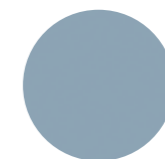

nuvola



4



Vista frontale zona notte con letto Mail, comodino sospeso e ponte scorrevole attrezzato di tubi appendiabiti.

Front view of sleeping area made up of Mail bed, suspended night table and sliding bridge equipped with hangers.





Cabina Spot composta da mensole con appendiabiti, mensola porta maglioni, basi a terra con cassetti. Armadio ad angolo attrezzato internamente di ripiani, tubi appendiabiti e illuminazione.

*Spot walk-in closet made up of shelves, hangers, ground units with drawers. Corner wardrobe equipped with shelves, hangers and lighting.*





Zona studio completa di scrittoio tipo 50 in appoggio a pensile con cassetti e casellari Denver.

*Study area made up of "50" desk over a wall unit with drawers and Denver wall units.*



Dettaglio testiera letto Mail in melaminico Seta e Petrolio.

Detail of Mail headboard in Seta and Petrolio melamine.



195 cm  
ambiente 11.5 mq

# 34

- A – Letto Mail con rete da 120cm
- B – Ponte a terra con ante scorrevoli
- C – Armadio ad angolo
- D – Cabina Spot
- E – Scrivitoio tipo 50, L150cm
- F – Casellari Denver



rovere

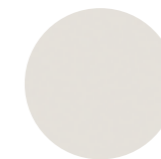

seta



petrolio



tortora





La colonna Air, grazie alla possibilità di avere i fianchi semi aperti, permette un utilizzo agevole come comodino.

*The Air wardrobe, thanks to the possibility of having the sides open, allows an easy use as a bedside table.*

Zona letto composta da colonna Air uso comodino, ponte battente e letto Pilot.

*Sleeping area made up of Air wardrobe, hinged door bridge and Pilot bed.*





Cabina spogliatoio 60 attrezzata internamente di ripiani, tubi appendiabiti e illuminazione.  
"60" dressing closet equipped with shelves, hangers and lighting.



Zona studio composta da scrittoio sospeso Base, pensili a giorno e con anta battente, cassetiera su ruote con top vassoio e pouf imbottito.

*Study area made up of Base suspended desk, wall units, chest of drawers on wheels with top tray and upholstered pouf.*

## Scrittoi sospesi



E1 Scrittoio sospeso Isola  
*Isola suspended desk*



E2 Scrittoio sospeso Pad  
*Pad suspended desk*



E3 Scrittoio sospeso Tablet  
*Tablet suspended desk*

## Scrittoi sospesi



Una nuova gamma di scrittoi sospesi  
che si abbinano alle nuove forme e colorazioni  
della collezione.

*A new range of suspended desks  
that match the new shapes and colors  
of the collection.*



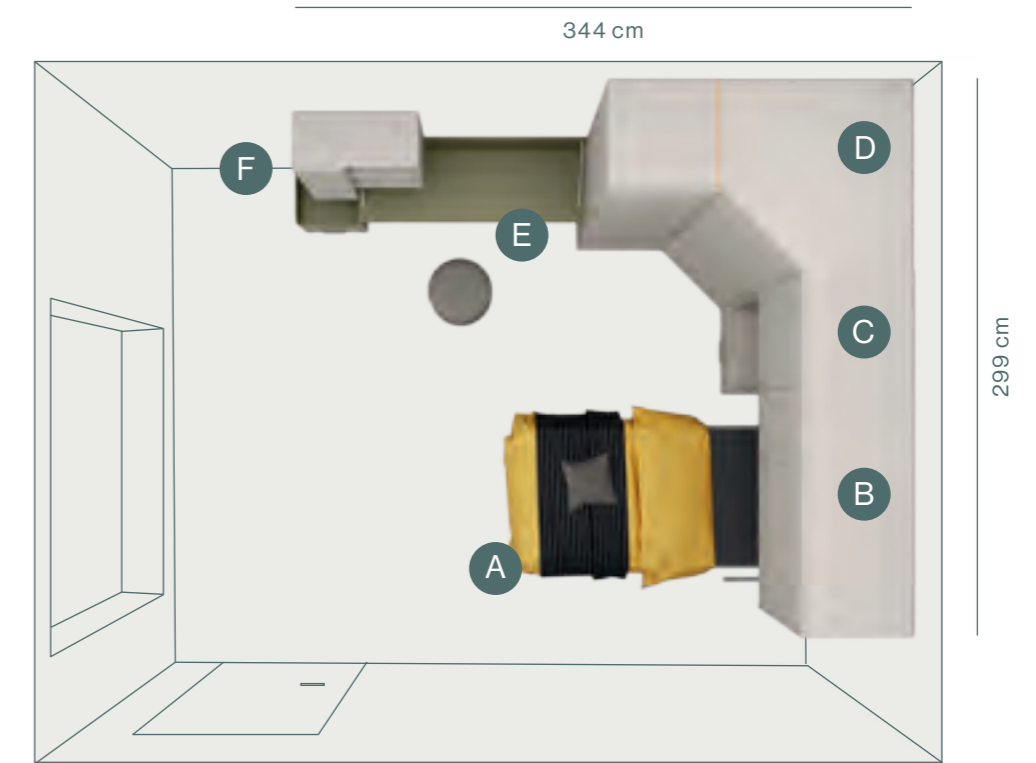
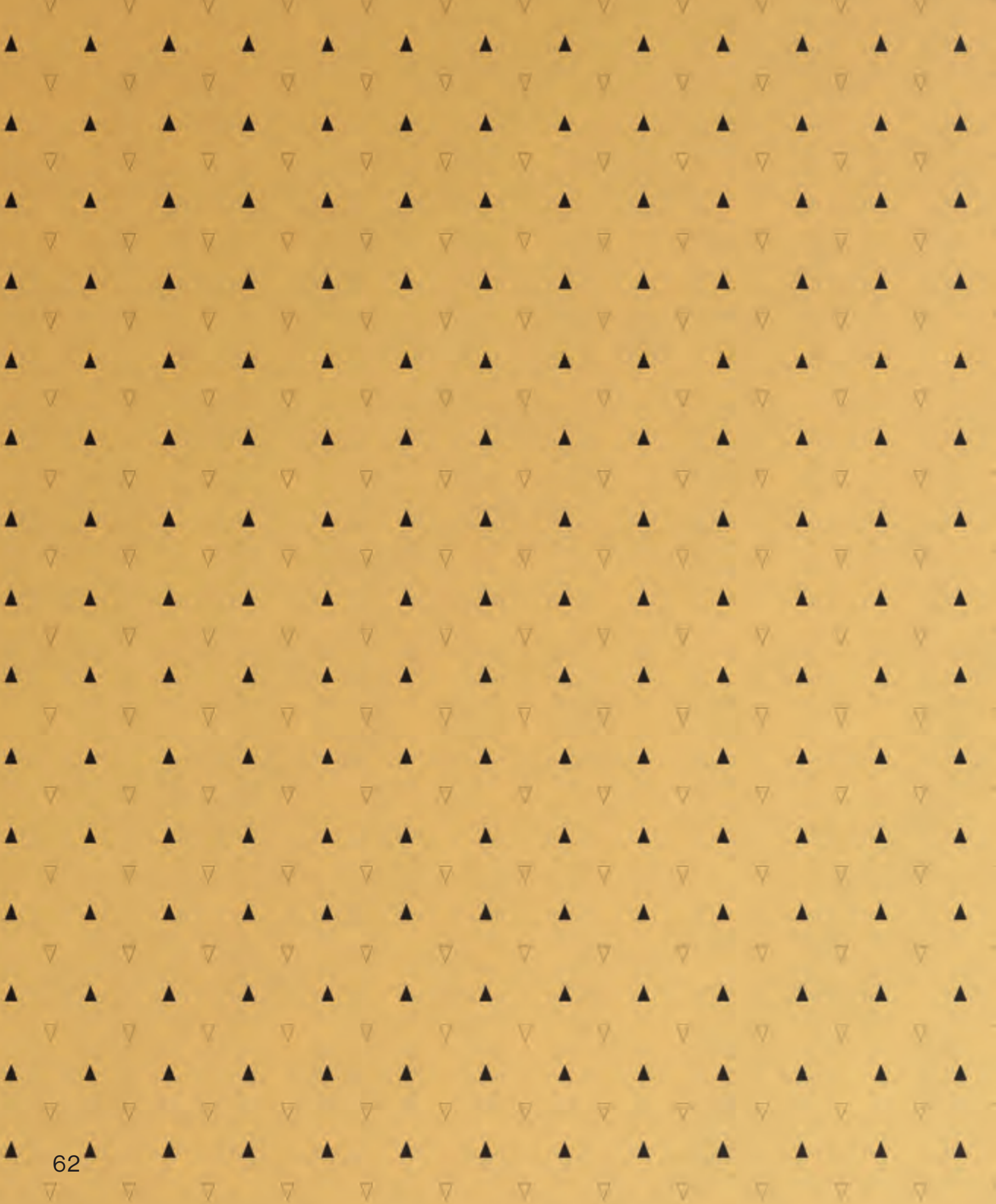

ambiente 11 mq



# 35

- A – Letto Pilot con rete da 90cm
- B – Ponte a terra con ante battenti
- C – Colonna Air
- D – Cabina spogliatoio 60
- E – Scrivania sospesa Base L150cm
- F – Box pensili

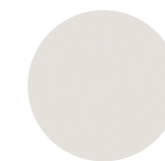

seta



ossidato



salvia





Zona studio composta da scrittoio tipo 52 con gambe Fado, casellari Cosmo, cassetiera su ruote e sedia Wave imbottita su ruote.

*Study area made up of "52" desk with Fado legs, Cosmo wall units, chest of drawers on wheels and Wave upholstered chair on wheels.*





Divano letto imbottito in tessuto In&Out S095 contenitore con rete rialzabile orizzontale.

*Upholstered sofa bed in In&Out S095 fabric with bed base lift-up mechanism.*

Il divano letto contenitore con rete rialzabile è utile nel momento in cui si necessita di spazio supplementare.

*The sofa bed with storage and bed base lift-up mechanism is useful when additional space is needed.*





Ponte a terra scorrevole con estetica Blad attrezzato internamente di tubi appendiabiti.

*Blad sliding door bridge equipped with hangers.*







Colonna Open con fianco destro finestra uso comodino e cassettera.

Open wardrobe with right side with window, to use as night table.

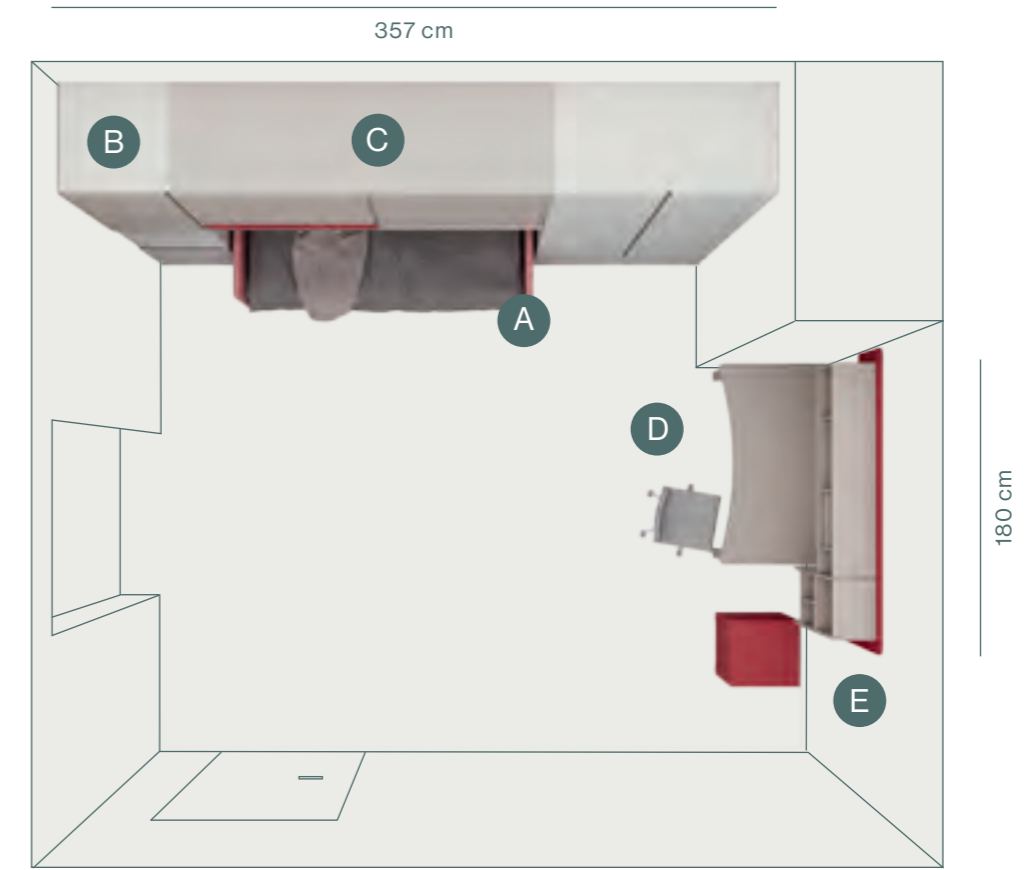

ambiente 10 mq

# 36

- A – Divano letto imbottito con box laterale con rete da 80cm
- B – Colonna Open
- C – Ponte a terra con ante scorrevoli Blad
- D – Scrivitoio tipo 50, L150cm
- E – Casellari Cosmo



olmo sbiancato



tortora

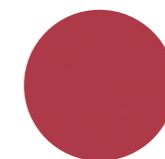

pepper

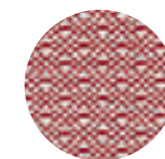

in&out S095



Zona studio composta da scrittoio tipo 45, libreria a spalla, casellari Qubo, cassetiera su panca e pouff imbottito.

*Study area made up of "45" desk, bookcase, Qubo wall units, chest of drawers on ground bench and upholstered pouff.*





Composizione di basi a terra con cassetti in melaminico Grigio con maniglia T53 e T49 e specchio a parete.

*Group of chests of drawer in Grigio melamine with T53 and T49 handle and mirror.*





Ponte a terra attrezzato internamente di tubi appendiabiti, letto Tablet con inserto laccato.

*Hinged door bridge equipped with hangers, Tablet bed with lacquered tab.*

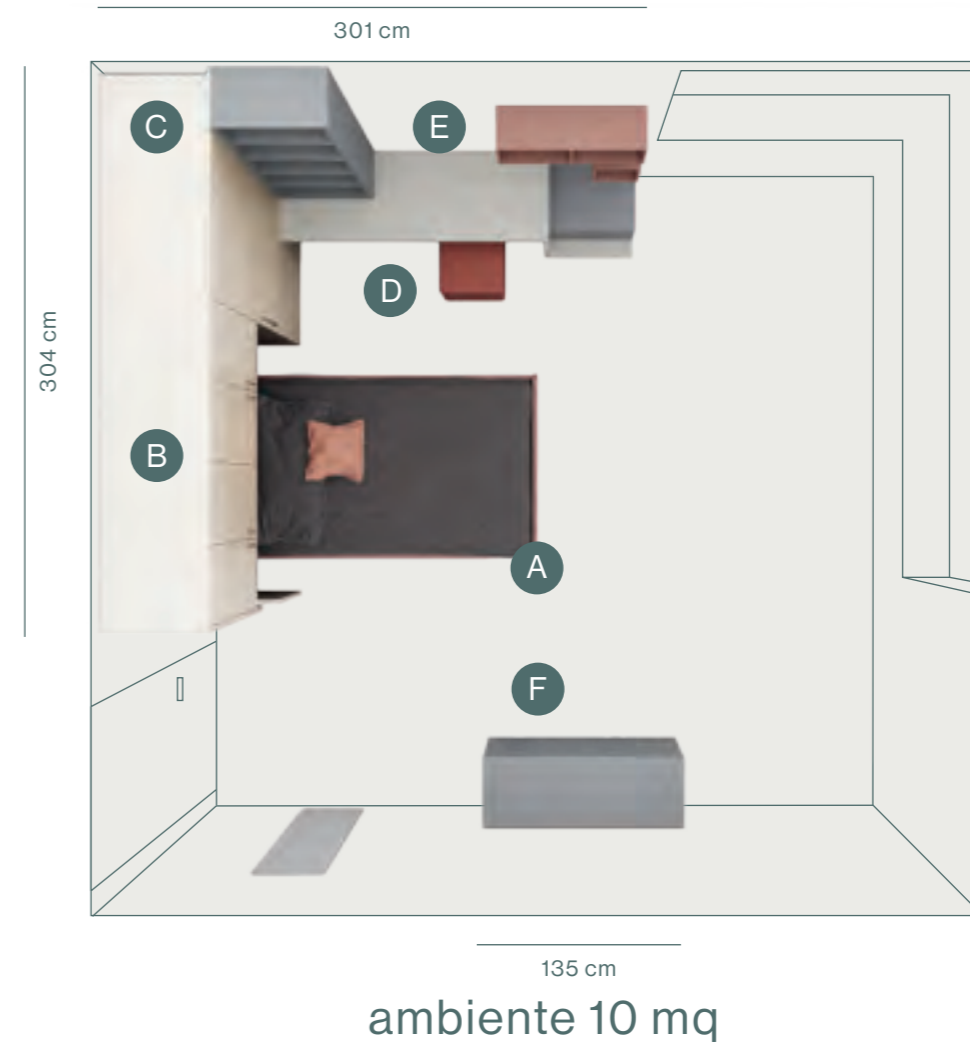

# 37

- A – Letto Tablet Side con rete da 120cm
- B – Ponte a terra con ante battenti
- C – Armadio Corner
- D – Scrivitoio tipo 45, L180cm
- E – Casellari Qubo
- F – Cassettiere

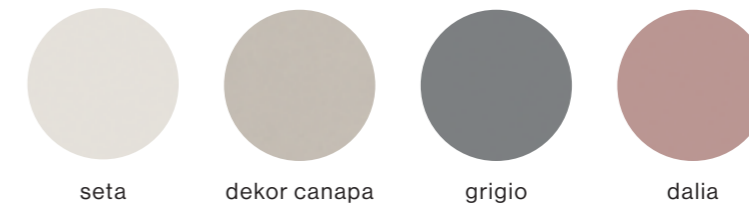

Carta da parati Fish  
*Fish Wallpaper*

Valorizzare le pareti con una decorazione  
giocosa dai toni delicati.

*Enrich the walls with a playful decoration  
with delicate tones.*

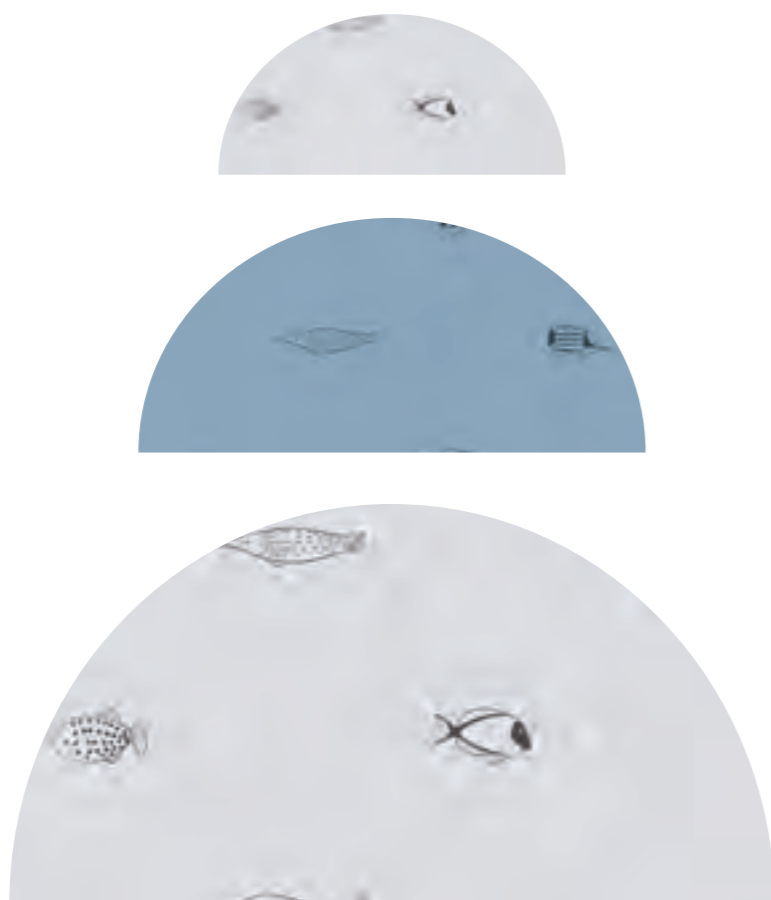





La sovrapposibilità dei letti Artiko permette di contenere lo spazio del dormire durante il giorno a favore dello spazio gioco.

*The overlap of the Artiko beds allows to contain the sleeping space during the day in favor of the play space.*



Letti polifunzionali Artiko Medio su ruote e Artiko Estraibile con cassetti in melaminico Cobalto.

*Artiko Medio multi-functional bed on wheels and Artiko Estraibile with drawers on tracks in Cobalto melamine.*





Zona studio composta da scrittoio tipo 46 con gamba Greca, sedia Ekipe imbottita su ruote.

Study zone made up of "46" desk with Greca leg, Ekipe upholstered chair on wheels.



Armadio battente attrezzato internamente di cassettera, ripiano e tubi appendi abiti. Maniglia T91 laccata Cobalto.

*Hinged wardrobe equipped with drawer pack, shelf and hangers. Detail of T91 handle in Cobalto lacquered finish.*





Vista frontale letti Artiko Medio ed Estraibile in melaminico Cobalto.

Front view of Artiko Medio and Artiko Estraibile in Cobalto melamine.

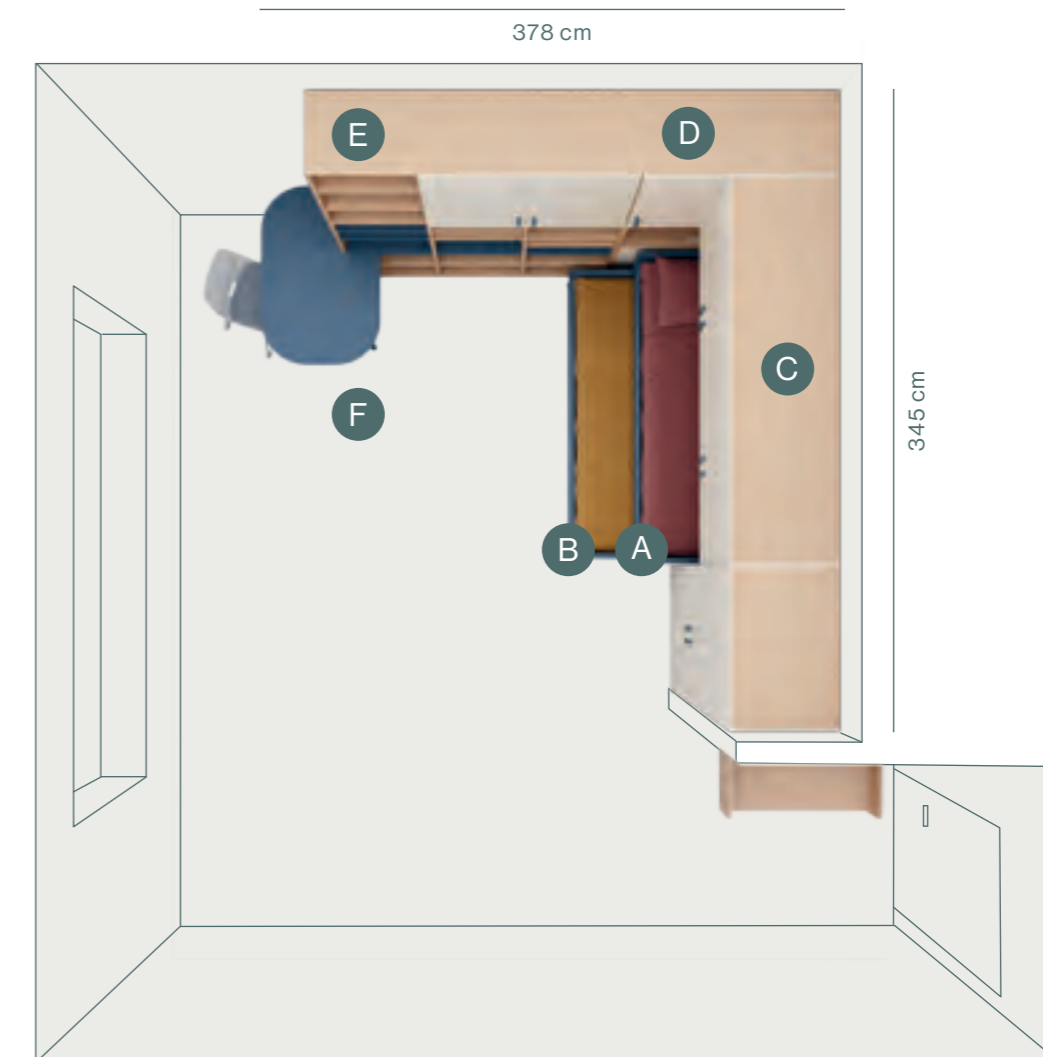

ambiente 12 mq



salvaspazio

# 38

- A – Letto Artiko Medio con rete da 80cm
- B – Letto Artiko Estraibile con rete da 80cm
- C – Ponte a terra con ante battenti
- D – Colonna Duplo
- E – Libreria a spalla
- F – Scrivania tipo 46, L120cm



rovere



beige



cobalto



Letto Mammut in dekor Canapa e Bronzo.  
Dettaglio piede letto conico laccato Tortora.

*Mammut bed in Canapa and Bronzo dekor.  
Detail of conical bed leg in Tortora lacquered finish.*





Zona studio composta da scrittoio tipo 36 con fianco Libreria, mensole Elle, sedia Terry laccata.

*Study area made up of "36" desk with Libreria leg in Canapa dekor, Elle shelves in Bronzo dekor and Terry lacquered chair.*



Cabina Van a due ante attrezzata internamente di ripiani, tubi appendi abiti e illuminazione.

Van dressing closet with two doors equipped with shelves, hangers and lighting.

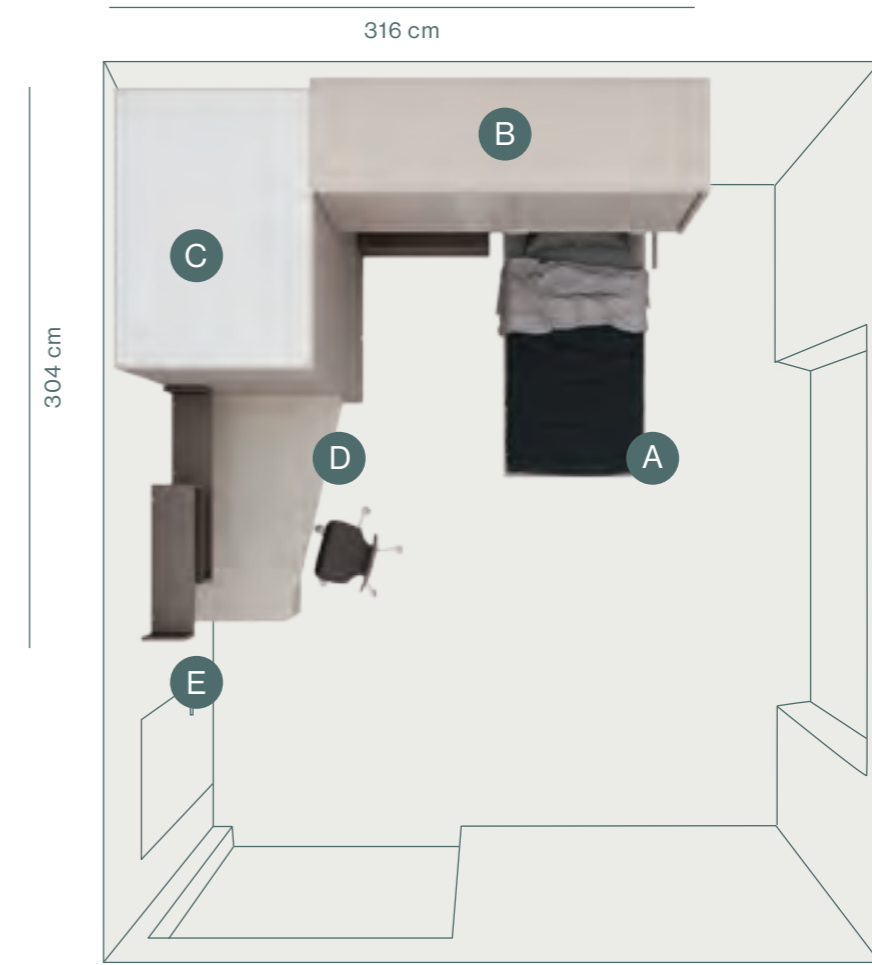

ambiente 10 mq

lui / lei

# 39

- A – Letto Mammut con rete da 90cm
- B – Ponte a terra con ante scorrevoli Soul
- C – Cabina Van, tipo F
- D – Scrivania tipo 36, L150cm
- E – Mensola Elle

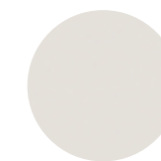

seta  
(struttura)



dekor canapa



dekor bronzo



tortora







Lo scrittoio a scomparsa è una buona soluzione quando si necessita massimo contenimento dello spazio.

*The movable desk is a good solution when you need maximum use of space.*



scorrevole

Colonna con scrittoio estraibile a scomparsa, completa di vano a giorno uso libreria e ante battenti.

*Wardrobe with movable desk, with open compartment to use as library and hinged door.*



Letti polifunzionali Artiko Medio ed Estraibile su ruote con cassetti estraibili su guide e protezione Tablet.

*Artiko Medio multi-functional bed on wheels and Artiko Estraibile with drawers on tracks and Tablet protection.*





Cabina spogliatoio 90 con Teka inserita sul fianco, attrezzata internamente di ripiani, tubi appendi abiti e illuminazione.

*"90" dressing closet with Teka on the side panel, equipped with shelves, hangers and lighting.*

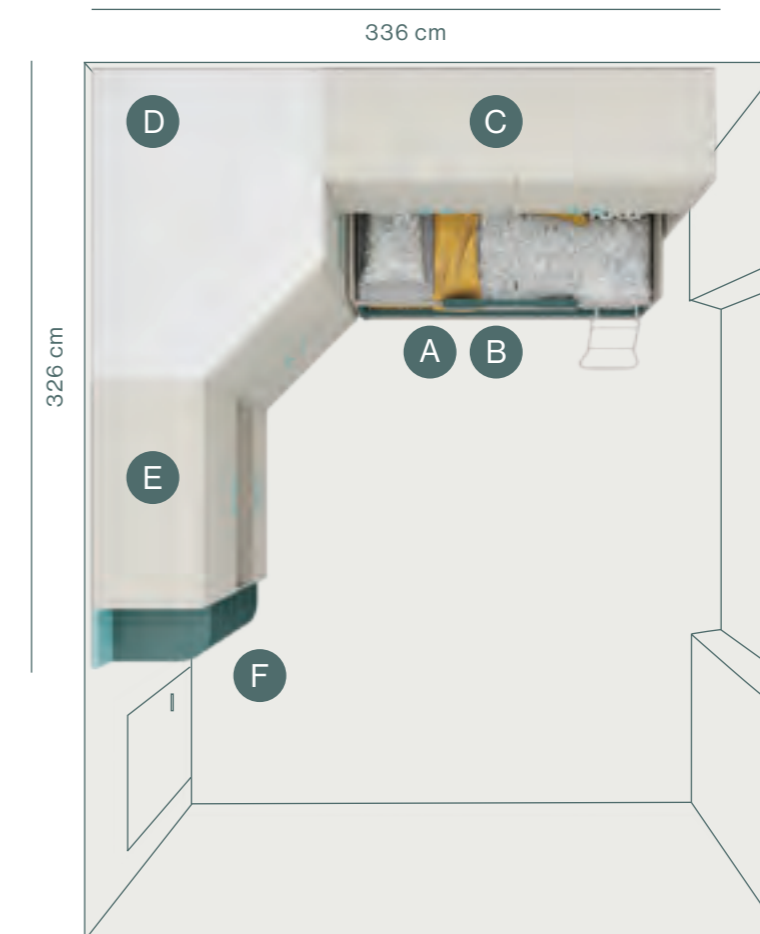

ambiente 11.5 mq



# 40

- A – Letto Artiko Medio con rete da 90cm
- B – Letto Artiko Estraibile con rete da 90cm
- C – Ponte a terra con ante battenti
- D – Cabina spogliatoio 90
- E – Colonna con scrittoio estraibile
- F – Terminale armadio



olmo chiaro

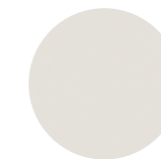

seta



cielo



petrolio



Ponti

Letto Rondi in melaminico Rovere con pediera rialzata e piedino conico laccato Paprika.

*Rondi bed in Rovere melamine with raised footboard and conical bed leg in Paprika lacquered finish.*



La nuova gamma di accessori interni  
permette un'organizzazione precisa  
dell'armadio.

*The new range of internal accessories  
allows precise organization of the  
wardrobe.*



Armadio battente attrezzato internamente di  
cassettiera, cesto estraibile in metallo, portapantaloni  
estraibile in metallo, ripiano e tubo appendi abiti.

*Hinged wardrobe equipped with drawer pack,  
movable metal basket, metal trouser rack,  
shelf and hangers.*





Zona studio composta da scrittoio tipo 84 inserito sotto ponte con sedia Ekiye su slitta. Dettaglio colonna Air uso comodino.  
*Study area made up of "84" desk under the hinged door bridge with Ekiye chair. Detail of Air wardrobe used as night table.*







Composizione studiata per una persona con zona notte e studio sottoponte.

*Solution for one person with sleeping area and study area under the bridge.*



Le soluzioni Mistral sono adattabili alle varie necessità dettate dal tempo e dalla crescita dei ragazzi.

*Mistral solutions are adaptable to the various needs dictated by the time and growth of the children.*

Composizione studiata per due persone con due zone notte sottoponte.

*Bedroom solution for two people with two sleeping area under the bridge.*



Letti Ranger in melaminico Rovere inseriti sotto ponte.

Ranger beds in Rovere melamine under bridge wardrobes.



ambiente 13 mq



# 41

- A – Letto Rondi con rete da 90cm
- B – Armadio con ante battenti e maniglia T88
- C – Ponti a terra con ante battenti
- D – Colonna Air
- E – Scrivania tipo 84, L132cm



rovere



beige



curcuma

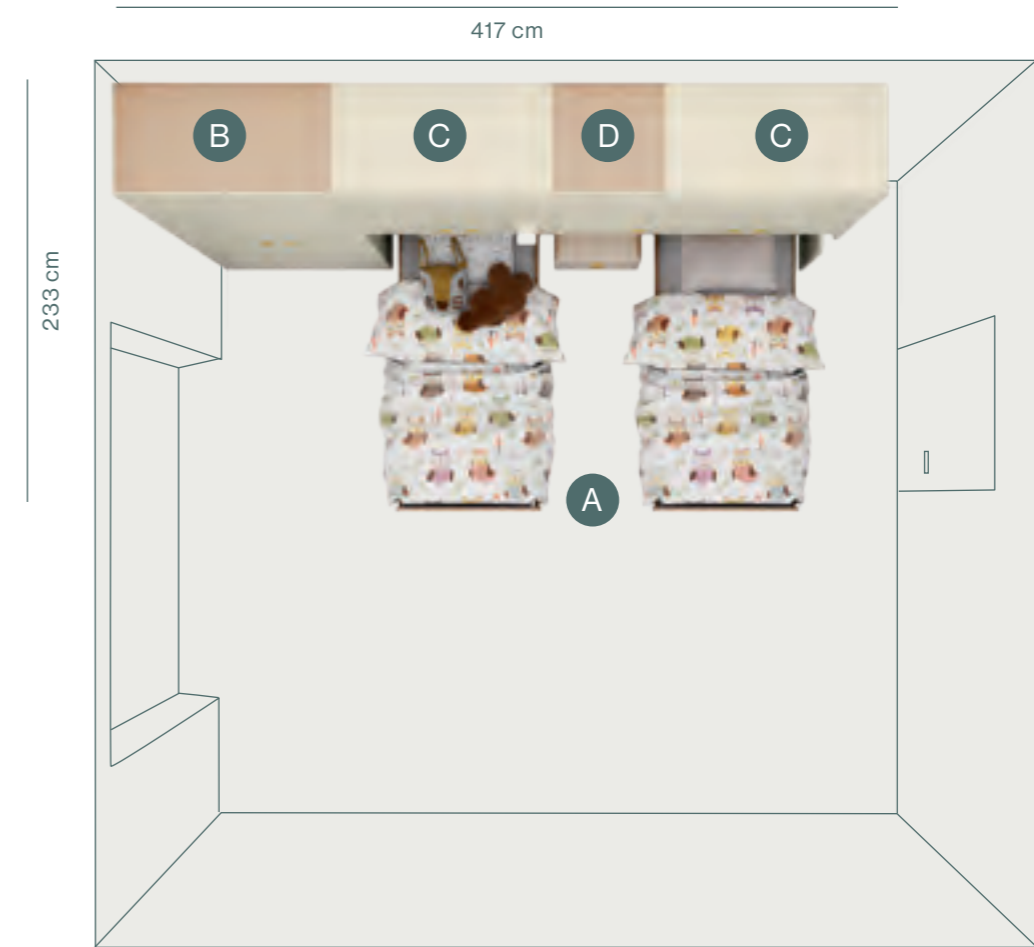

ambiente 13 mq



# 41 variante

- A – Letti Ranger con rete da 90cm
- B – Armadio con ante battenti e maniglia T79
- C – Ponti a terra con ante battenti
- D – Colonna Air



rovere



beige

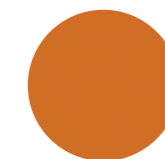

paprika

Carta da parati Leaf  
*Leaf Wallpaper*

Valorizzare le pareti con una decorazione delicata  
dai toni morbidi e adattabili a tutte le situazioni.

*Enrich the walls with a delicate decoration with soft  
tones and adaptable to all situations.*

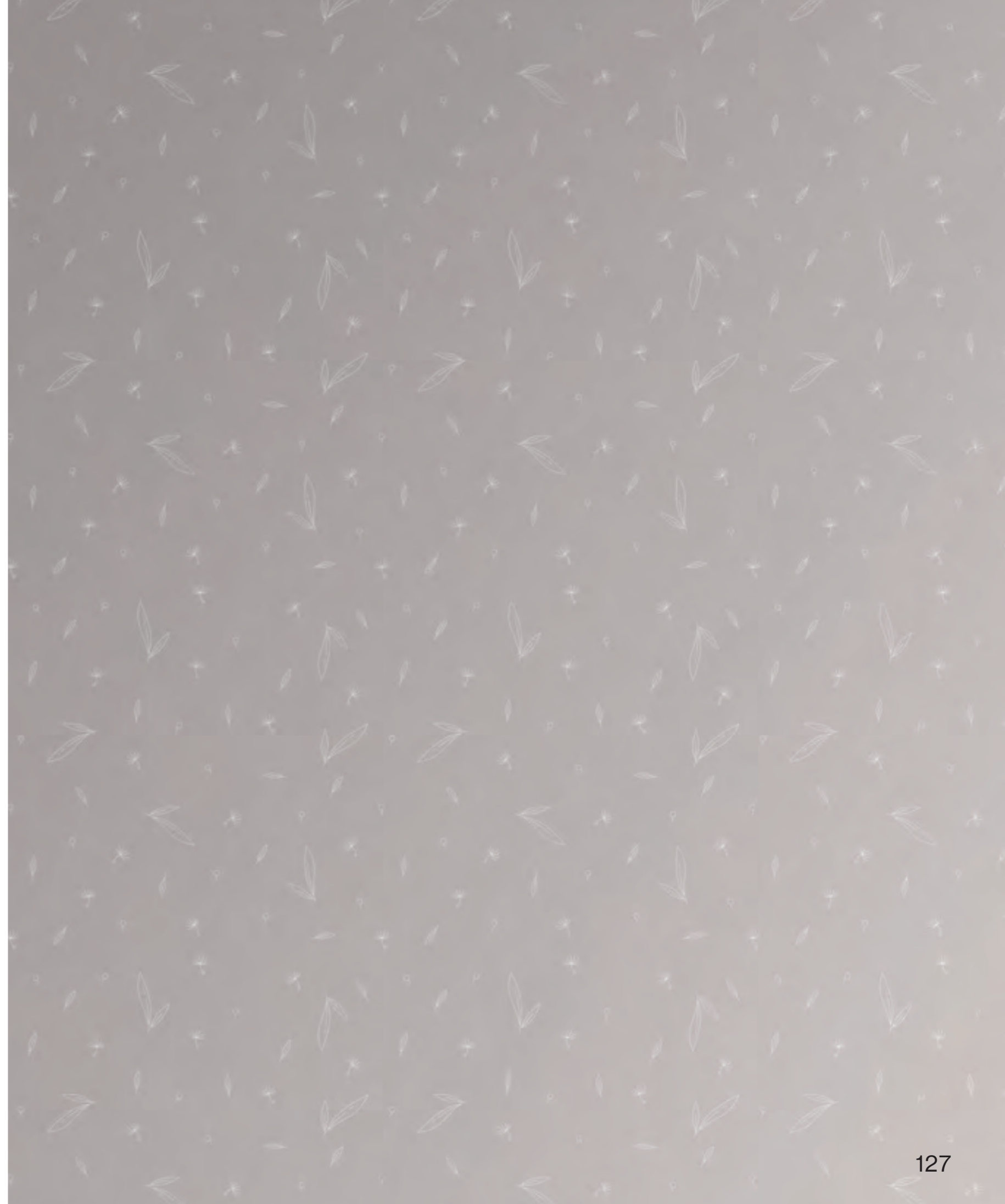
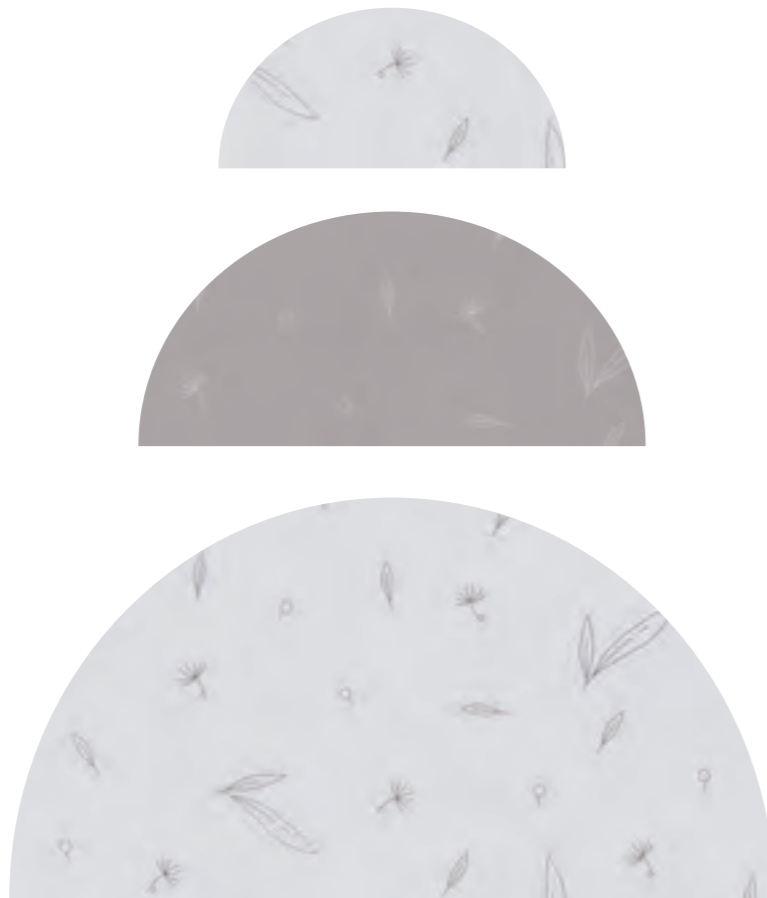





Zona studio composta da scrittoio tipo 50 in appoggio a base cassetiera, libreria Madison, sedia Party imbottita su ruote.

*Study area made up of "50" desk over a chest of drawer, Madison bookcase, Party upholstered chair on wheels.*





Divano letto Priddy contenitore, con rete rialzabile orizzontale.

*Priddy sofa bed with container and bed base lift-up mechanism.*





Colonna armadio battente con vano a giorno e ripiani.  
*Hinged wardrobe with open compartments and shelves*





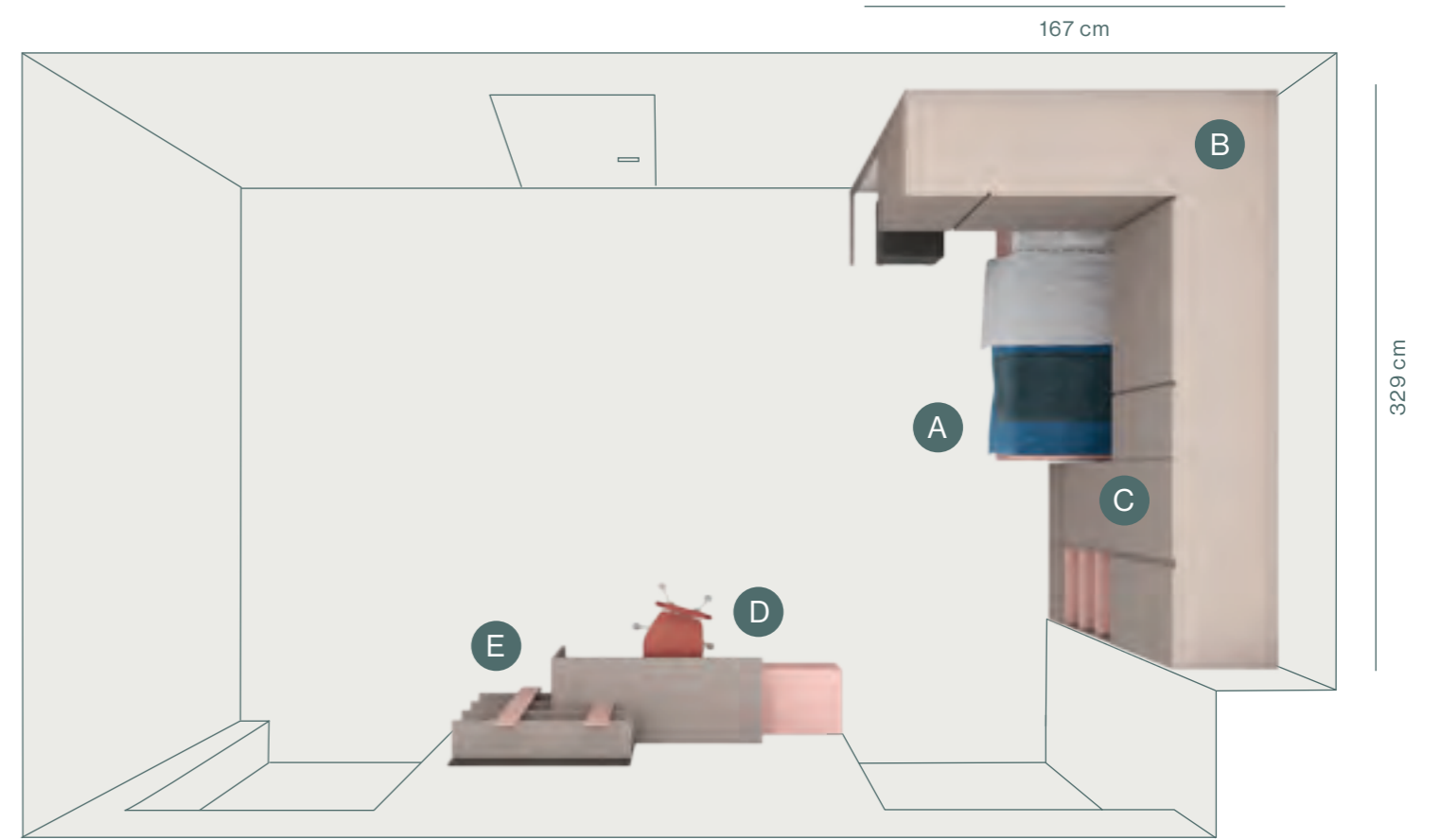

ambiente 10 mq

# 42

- A – Divano letto Priddy con rete da 90cm
- B – Ponte ad angolo con ante battenti
- C – Armadio con anta battente e maniglia T76
- D – Scrivania tipo 50, L150cm
- E – Libreria Madison



olmo sbiancato

dekor bronzo

tortora

dalia





Gli armadi a ponte si possono utilizzare sopra scrittoi e letti quando si necessita di spazio contenitivo aggiuntivo.

*The bridge wardrobes can be used above desks and beds when additional storage space is needed.*



Barra Surf retroilluminata attrezzata di testiera letto a pannello e mensola in metallo laccata, basi a terra con cassetti, letto imbottito contenitore.

*Surf bar equipped with panel headboard, lacquered metal shelf and lighting, ground units with drawers, upholstered bed with container.*



Ponte a terra attrezzato internamente di appendiabiti e illuminazione.  
*Ground bridge equipped with hangers and lighting.*





*Basi a terra con cassetti e cuscini imbottiti  
uso seduta.*

Ground units with drawers and pillows over  
them to sit on.



ambiente 10.5 mq

# 43

- A – Giroletto imbottito con rete da 80cm
- B – Armadio con maniglia T76
- C – Ponte ad angolo con ante battenti
- D – Scrivitoio sottoponte L207
- E – Terminale libreria



olmo chiaro

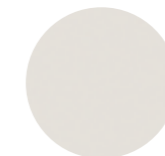

seta



grigio



cobalto

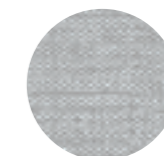

oregon S031





Testiera letto Hulk in melaminico Ossidato con pannello imbottito in tessuto Oregon S037.

*Hulk headboard in Ossidato melamine with upholstered panel in Oregon S037 fabric.*



Il ponte ad angolo permette una doppia e compatta soluzione notte.

*The corner bridge wardrobe allows a compact and double sleeping solution.*





Zona studio composta da due scrittoi tipo 36 in appoggio a base con cassetti, casellari Tablet, due sedie Terry laccate.

*Study area made up of "36" desk over a chest of drawer, Tablet wall units, two Terry lacquered chairs.*







Armadio battente attrezzato internamente di cesto estraibile in metallo, ripiano e tubi appendiabiti.

*Hinged wardrobe equipped with movable metal basket, shelf and hangers.*



# 44

- A - Due letti Hulk con giroletto e rete da 80cm
- B - Ponte ad angolo con ante battenti
- C - Terminale libreria con specchio
- D - Due scrittoi tipo 36, L135cm
- E - Casellari Tablet



ossidato



seta



nuvola

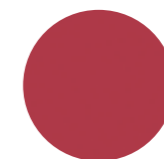

pepper

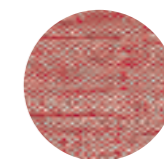

oregon S037



# Salvaspazio

Le camerette Mistral sono caratterizzate da elementi flessibili e personalizzabili a seconda dello spazio disponibile, del gusto e dell'età. Le soluzioni Salvaspazio propongono una cameretta completa quando lo spazio diventa un vincolo.

*Mistral bedrooms are characterized by flexible and customizable elements depending on the space available, taste and age. The space-saving solutions offer a complete bedroom where space is a constraint.*







Basi in appoggio su panca con cassetti e cassettoni e specchio a muro.

Ground unit over bench with drawers and mirror fixed on wall.





La zona studio e la zona notte  
 si integrano in un oggetto unico ma flessibile  
 ai diversi orari della giornata.

*The study and sleeping area merge  
 into a single flexible object at different  
 times of the day.*



estraibile



Letto polifunzionale Artiko Alto con scrittoi estraibili,  
 cassetti e protezione Tablet.

*Artiko multi-functional bed with movable desks and  
 drawers, with Tablet protection.*

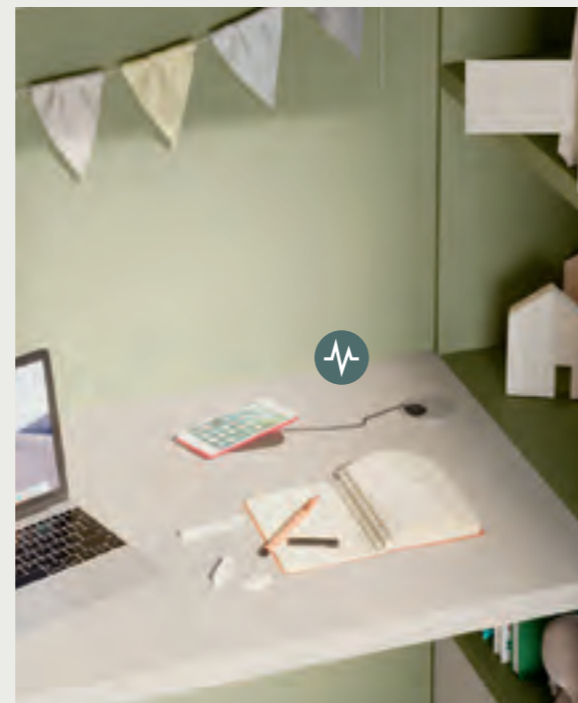

Scrivitoio tipo 84 sotto ponte completo di ricarica Wireless e passacavi.

"84" desk under the bridge equipped with Wireless charger and cable hole.

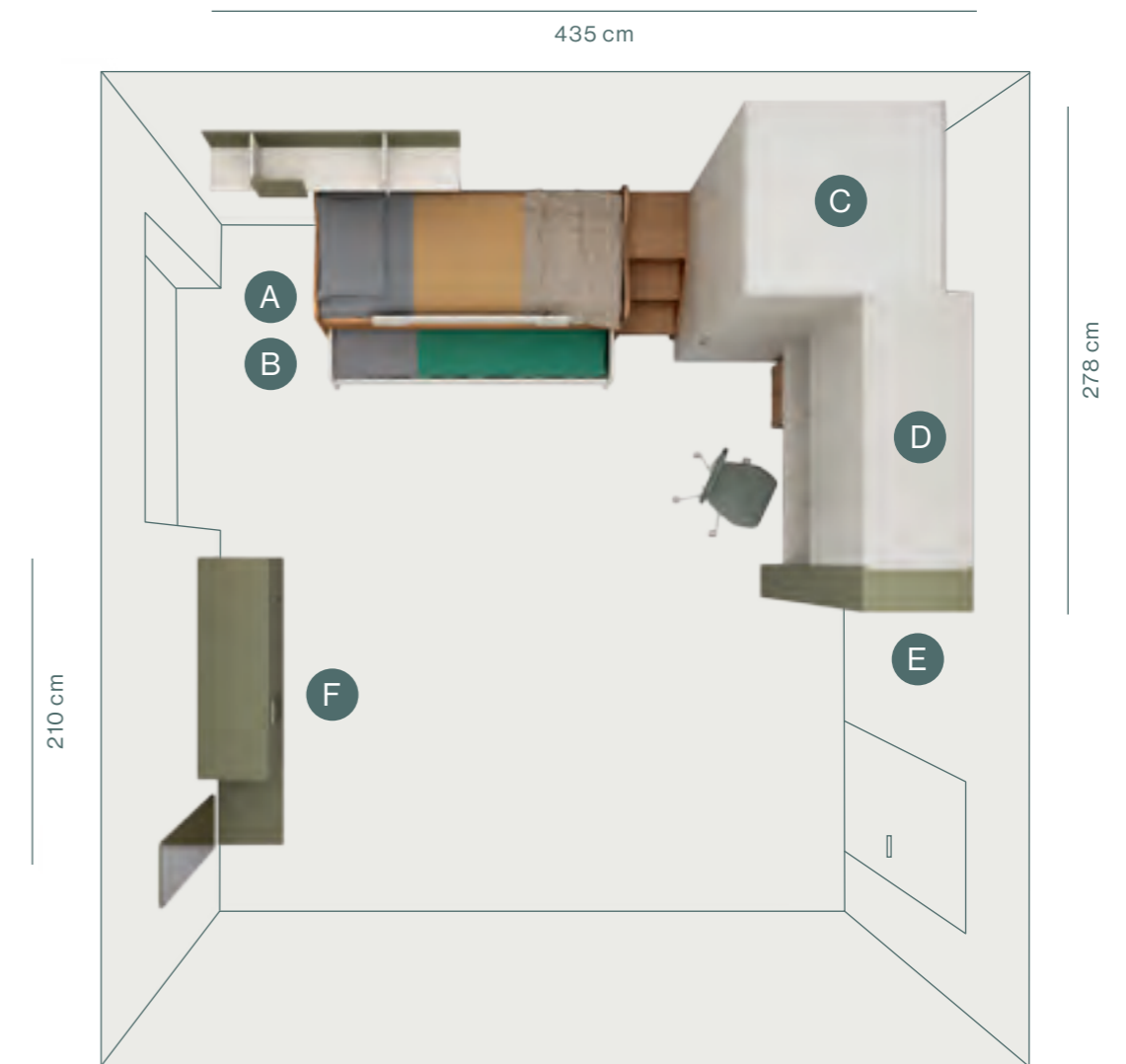

ambiente 12 mq



# 45

- A - Letto Artiko Alto con scrittoio e cassetti
- B - Letto Artiko Estraibile con rete da 90 cm
- C - Cabina Van, tipo C
- D - Ponte a terra con ante battenti
- E - Terminale libreria
- F - Cassettiere su panca



rovere



seta



dekor canapa



salvia





Armadio scorrevole Alve attrezzato internamente di cassetiera, ripiani, tubi appendi abiti e illuminazione.

*Sliding wardrobe with Alve door equipped with drawer pack, shelves, hangers and lighting.*







Il letto Polar unisce il letto e l'armadio in un oggetto versatile e contenitivo.

*The Polar bed merge wardrobe and bed into a single object, versatile and containing.*

## Letto polifunzionale Polar

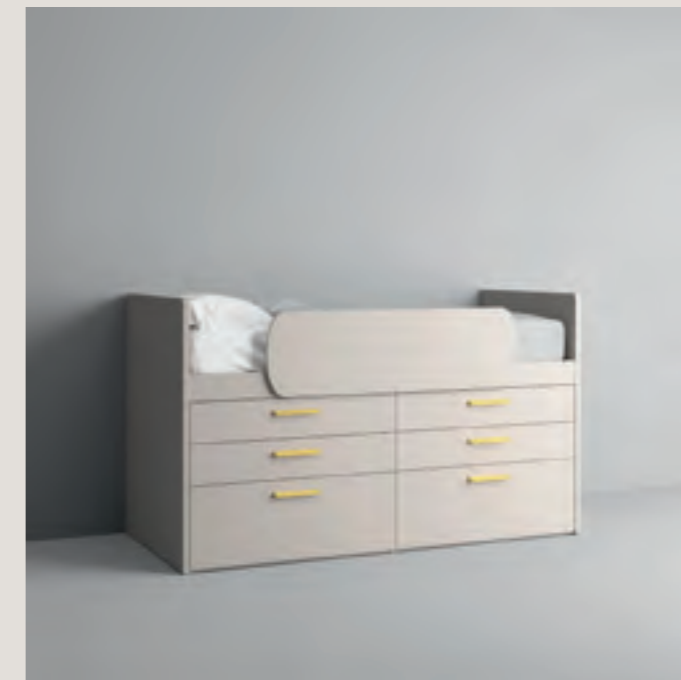

A1

Letto Polar

con quattro cassetti e due cassettoni, con protezione Mouse.

*Polar bed*

*with four drawers and two big drawers, with Mouse protection panel.*



A2

Letto Polar

con pannello fisso per accosto letto, due cassetti e un cassettone, protezione Mouse.

*Polar bed*

*with fixed panel for bed access, with two drawers and one big drawer, with Mouse protection.*

## Letto polifunzionale Polar



**A3** Letto Polar  
con quattro ante e protezione  
reclinabile Gate.

*Polar bed*

*with four doors and Gate  
reclining protection.*



**A4** Letto Polar  
con due ante e scrittoio  
estraibile, con protezione  
Tablet.

*Polar bed*

*with two doors and  
movable desk, with Tablet  
protection.*

Letto Polar con cassetti, ante battenti, protezione  
Mouse e scaletta Smart.

*Polar multi-functional bed with drawers, hinged  
doors, Mouse protection and Smart stepladder.*





Zona studio composta da scrittoio tipo 51 con gamba Lake, pensili a giorno e anta ribalta.

Study area made up of "51" desk with Lake leg, open units and flap door units.





Terminale armadio Free composto da ripiani, consolle e specchio, accostato a cassettera su ruote.

Free wardrobe terminal made up of shelves, console and mirror, next to a chest of drawers on wheels.

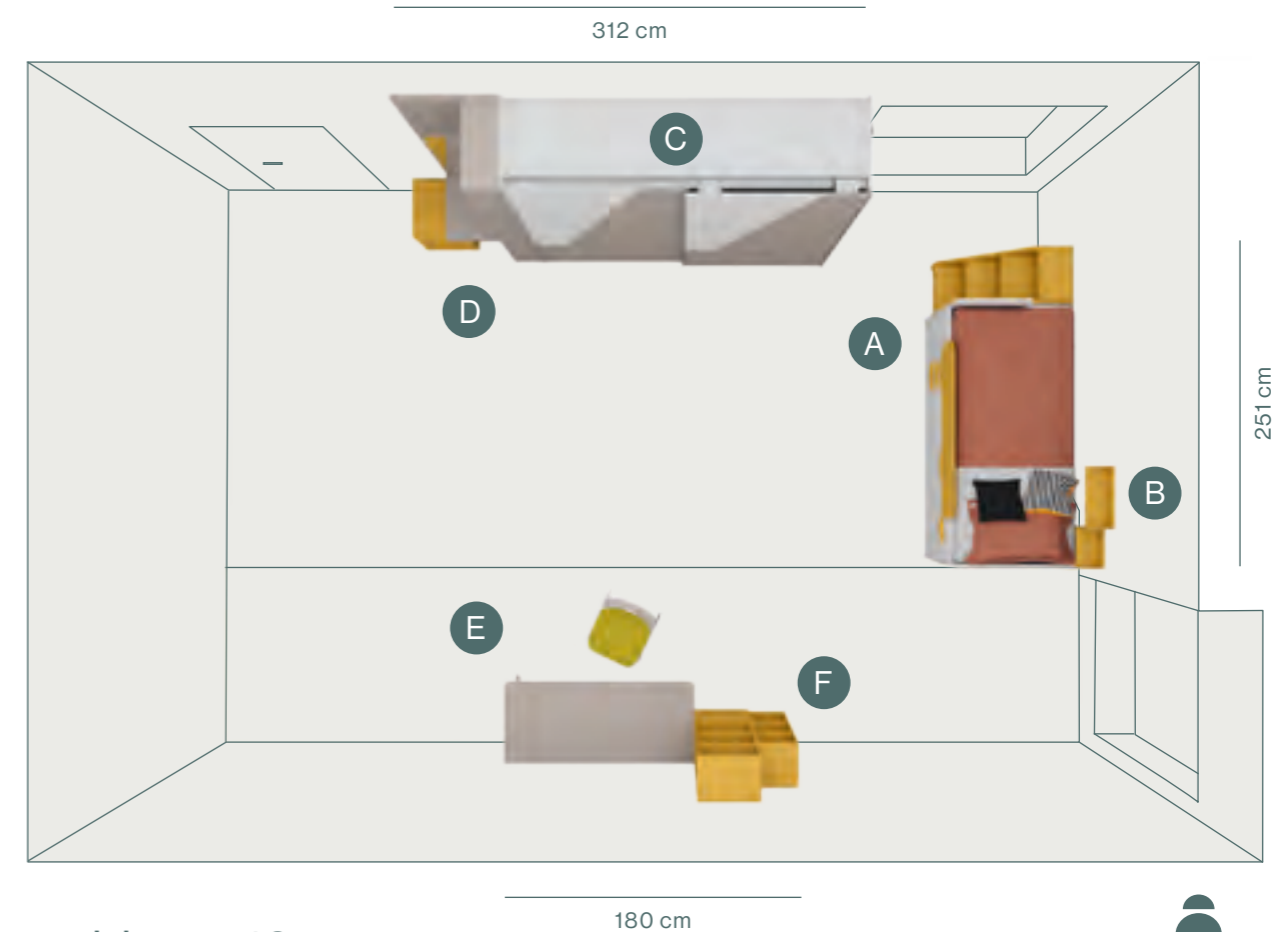

ambiente 13 mq



# 46

- A – Letto Polar con scaletta laterale
- B – Casellari Vega
- C – Armadio scorrevole con anta Alve
- D – Terminale Free
- E – Scrivitoio tipo 51, L150cm
- F – Box pensili

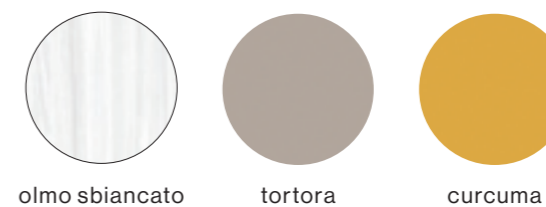





Il letto Avantgarde scorre sopra la sua scaletta per mostrare il letto inferiore.

*The Avantgarde bunk bed slide over his ladder to show the lower bed.*



scorrevole

Letto Avantgarde scorrevole con fianco Quadro e scaletta con camminata posteriore in dekor Canapa.

*Avantgarde sliding bunk bed with Quadro side panel and ladder with walk in Canapa dekor.*





scorrevole



Cabina angolo Covert con anta libreria scorrevole, attrezzata internamente di ripiani e tubi appendi abiti.

*Covert dressing closet with sliding library, equipped with shelves and hangers.*



Zona studio composta da scrittoio tipo 36 con fianco Basic e casellari Denver. Letto Square con testiera pannello, giroletto stondato e piedino conico.

*Study area made up of "36" desk with Basic leg and Denver wall units. Square bed with panel headboard, bed frame with rounded edges with conical bed leg.*



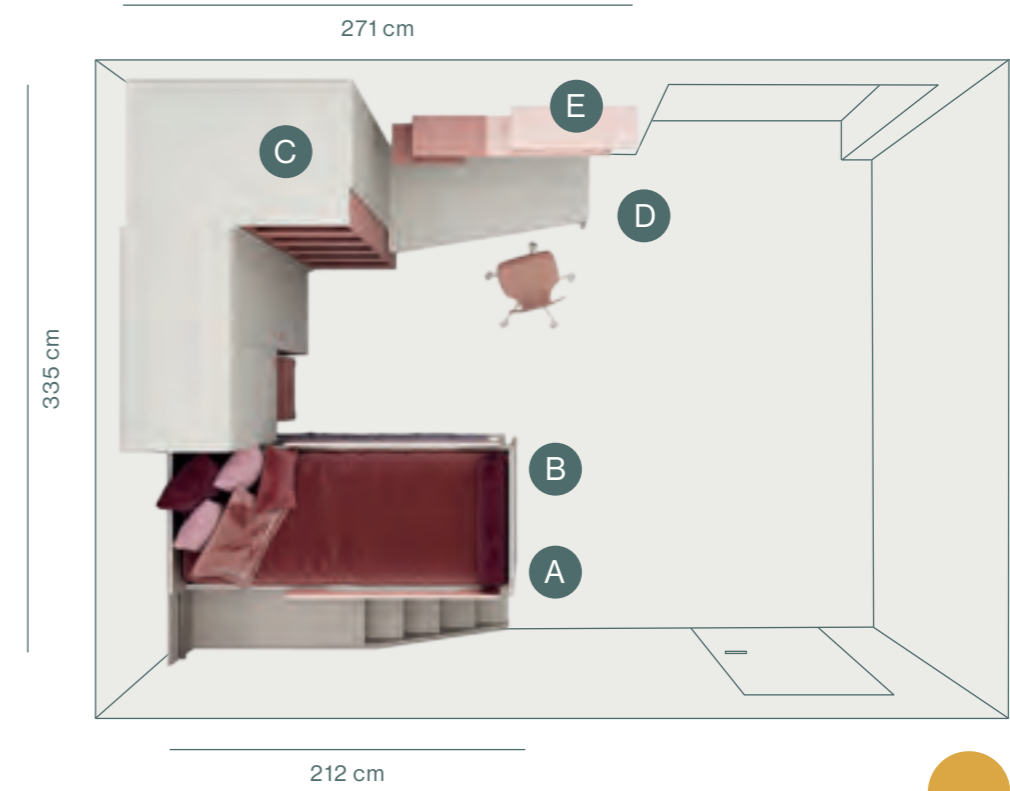

ambiente 9.5 mq



# 47

- A – Soppalco scorrevole Avantgarde
- B – Letto Square con giroletto e piede conico
- C – Cabina Covert 121
- D – Scrivania tipo 36, L150 cm
- E – Casellari Denver

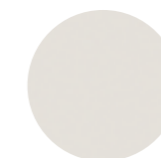

seta



dekor canapa

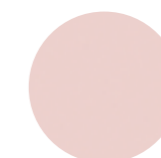

confetto



dalia



Letto Rondi con giroletto contenitore in melaminico Beige, inserito sotto castello a sopralco Zoom 90 con comodino a due cassetti.

*Rondi bed with 35cm high bed frame in Beige melamine located under the Zoom 90 loft bed with a night table with two drawers.*





Armadio battente con maniglia Gola, attrezzato internamente di ripiani e appendiabiti. Vano a giorno in melaminico Cielo.

*Hinged door wardrobe with Gola handle, equipped with shelves and hangers. Open compartments in melamine.*



Letto a soppalco Zoom 90 con fianco libreria e scaletta con contenitore.

*Zoom 90 loft bed with a library as side panel and a step ladder with container.*



Vista dall'alto della zona studio composta da fianco libreria, scrittoio tipo 08 e pouf imbottito.

Top view of study area made up of library, "08" desk and upholstered pouff.

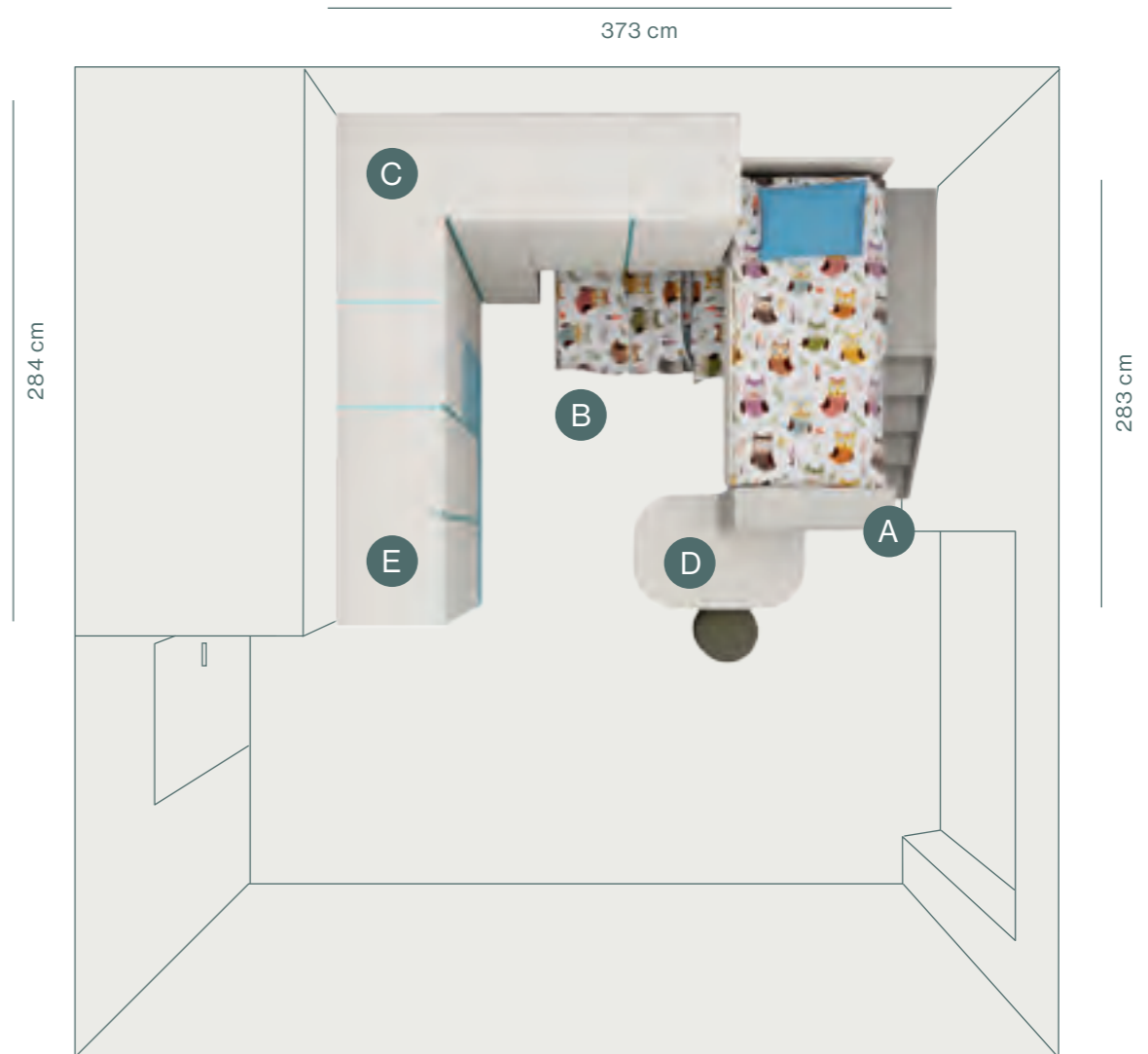

ambiente 13.5 mq



# 48

- A – Soppalco Zoom 90 con salita posteriore e fianco libreria
- B – Letto Rondi con contenitore con rete da 90cm
- C – Armadio ad angolo con maniglia Gola
- D – Scrittoio tipo 08, L120 cm
- E – Armadio con maniglia Gola



olmo chiaro    seta    beige    cielo





Zona studio composta da scrittoio tipo 52 in appoggio a cassettera e gamba Rasty, casellari Alaba in melaminico Seta e metallo laccato Paprika.

*Study zone made up of "52" desk over a chest of drawer with Rasty leg, Alaba wall units in Seta melamine and Paprika lacquered finish.*





Letto Avantgarde Mini scorrevole con fianco Silo in melaminico Rovere e Paprika, con protezione Tablet in melaminico Rovere e dekor Canapa.

*Avantgarde Mini bunk sliding bed with Silo side panel in Rovere and Paprika melamine, with Tablet protection in Rovere melamine and Canapa dekor.*



scorrevole



La salita del letto Avantgarde Mini si trasforma in comodino per il letto inferiore.

*The stepladder of the Avantgarde Mini sliding bunk bed turns into a bedside table.*



Vista letto inferiore estratto con zona comodino composta da vani a giorno e cassetti.

View of low bed extracted with night table zone made up of open compartments and drawers.

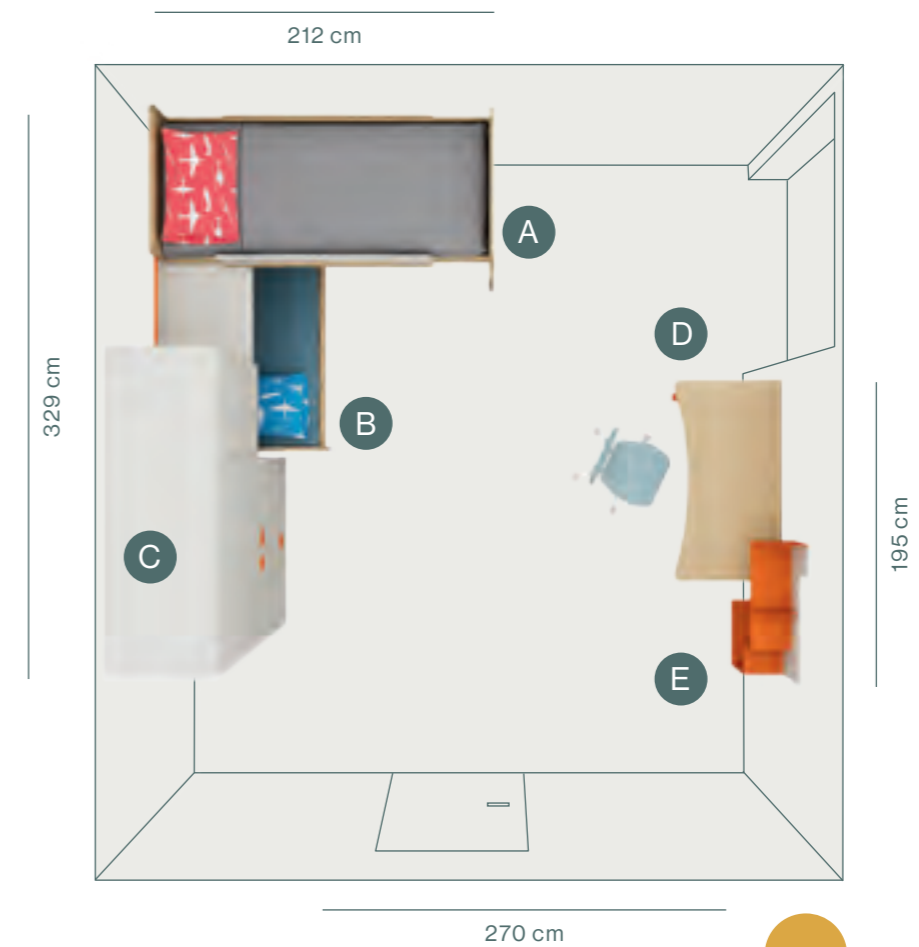

ambiente 11.5 mq



# 49

- A – Soppalco scorrevole Avantgarde Mini
- B – Artiko Estraibile con rete da 90cm
- C – Armadio con maniglia T79
- D – Scrivitoio tipo 52, L150cm
- E – Casellari Alaba



rovere



seta

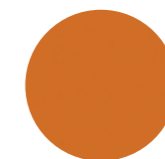

paprika





Armadio Mega con anta Soul, attrezzato internamente di ripiani e tubi appendi abiti.

Mega wardrobe with Soul door equipped with shelves and hangers.







Zona studio composta da scrittoio tipo 78 con gambe Basic in dekor Canapa, in appoggio a pensili con cassetti e anta in dekor Canapa, libreria sospesa Madison in melaminico Menta e Petrolio, sedia Wave bianca.

*Study area made up of "78" desk with Basic leg in Canapa dekor, over wall units with drawers and flap door in Canapa dekor, Madison suspended bookcase in Menta and Petrolio melamine, Wave white chair.*

La lettura e la musica trovano spazio affianco agli scrittoi, per una rapida pausa studio.

*Reading and music find the right space near desks, for a quick study break.*





Vista dall'alto del Soppalco Zoom con scaletta, camminata posteriore e libreria di compensazione uso comodino.

Top view of bridge bunk bed with stepladder, back walkway and compensation library to use as night table.

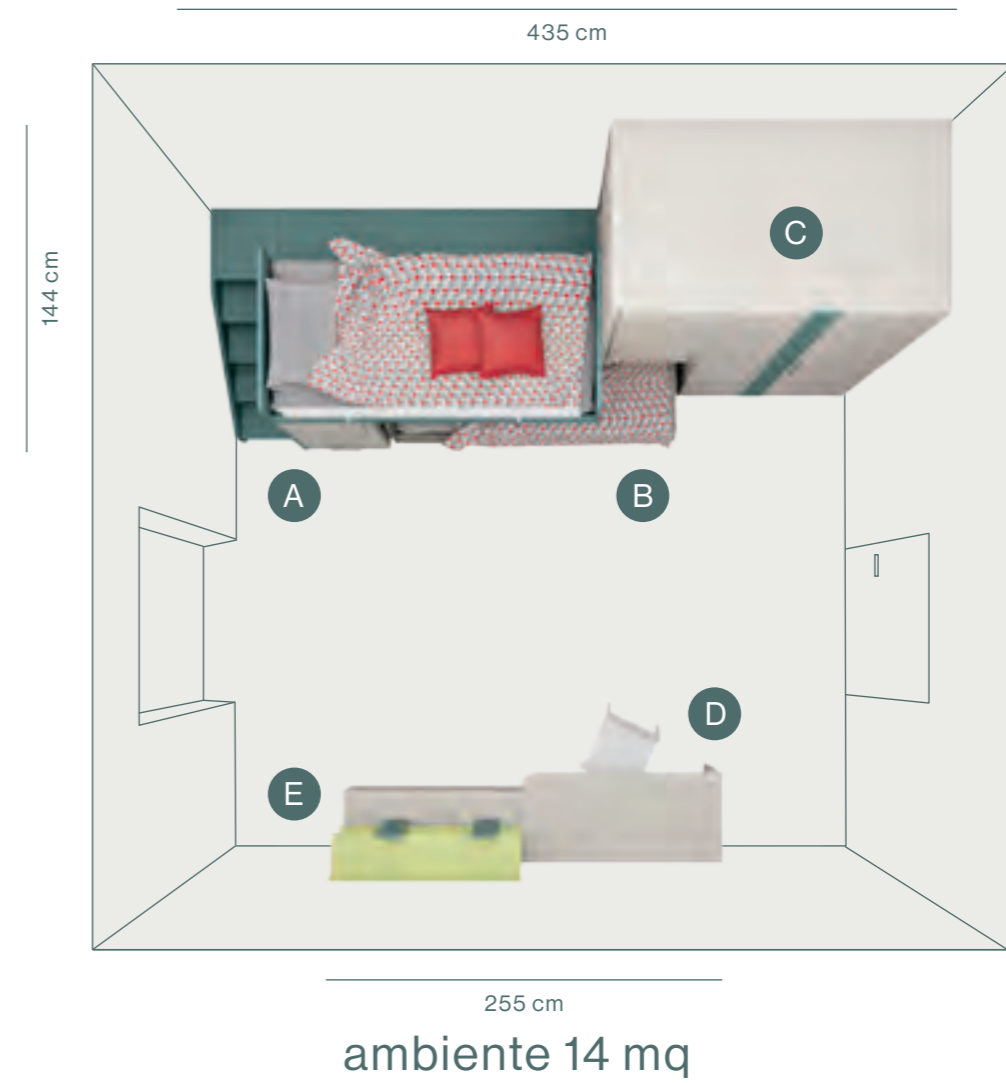

# 50

- A – Soppalco Zoom con rete da 90cm
- B – Divano letto imbottito con box laterale
- C – Armadio Mega
- D – Scrivitoio tipo 78, L150cm
- E – Libreria sospesa Madison



seta



dekor canapa



menta



petrolio

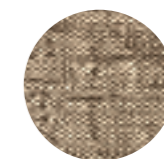

oregon S033

Carta da parati Triangle  
*Triangle Wallpaper*

Valorizzare le pareti con una decorazione geometrica,  
per chi ama forme moderne ma con toni caldi.

*Enrich the walls with a geometric decoration, for those  
who love modern shapes with warm tones.*

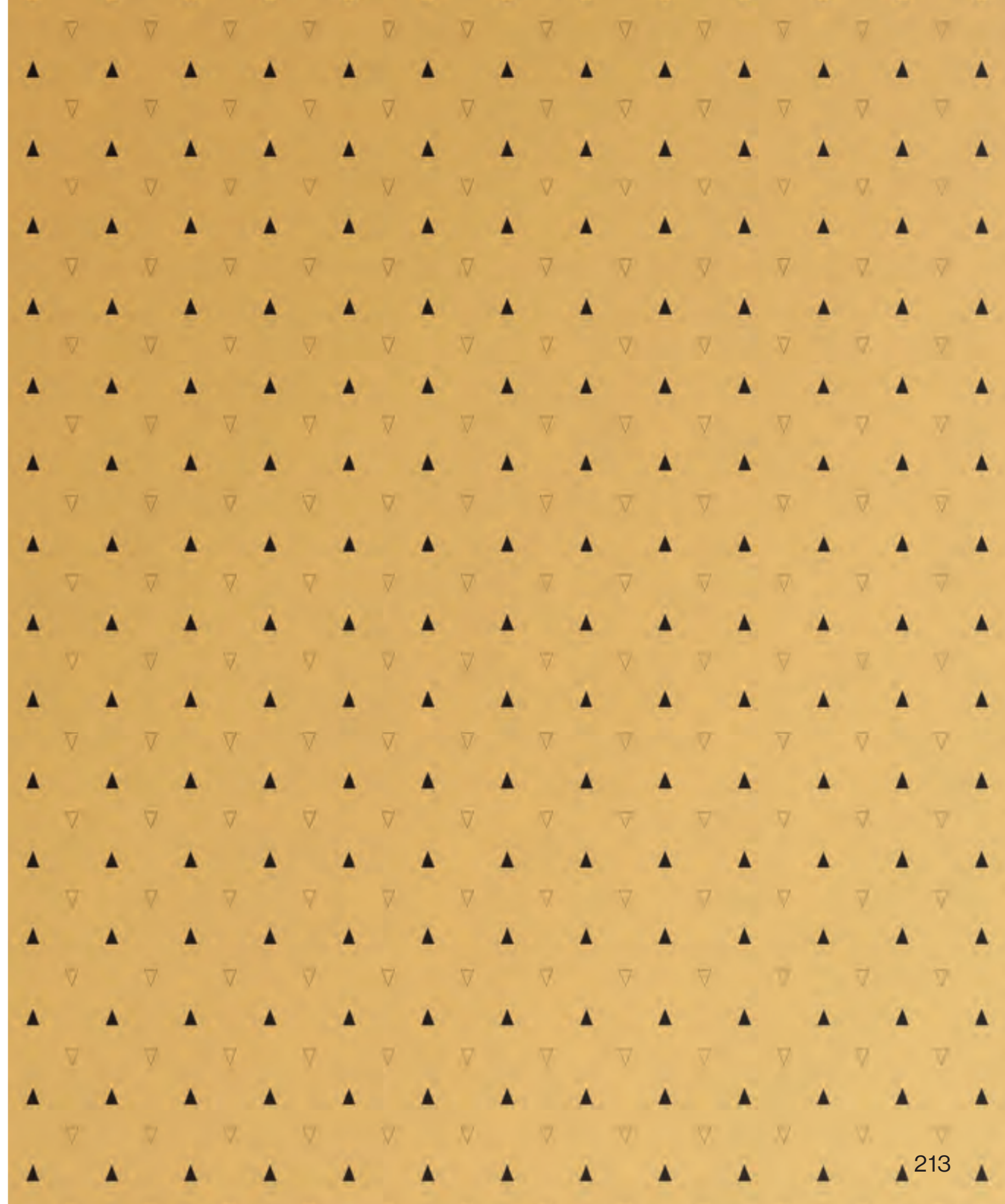
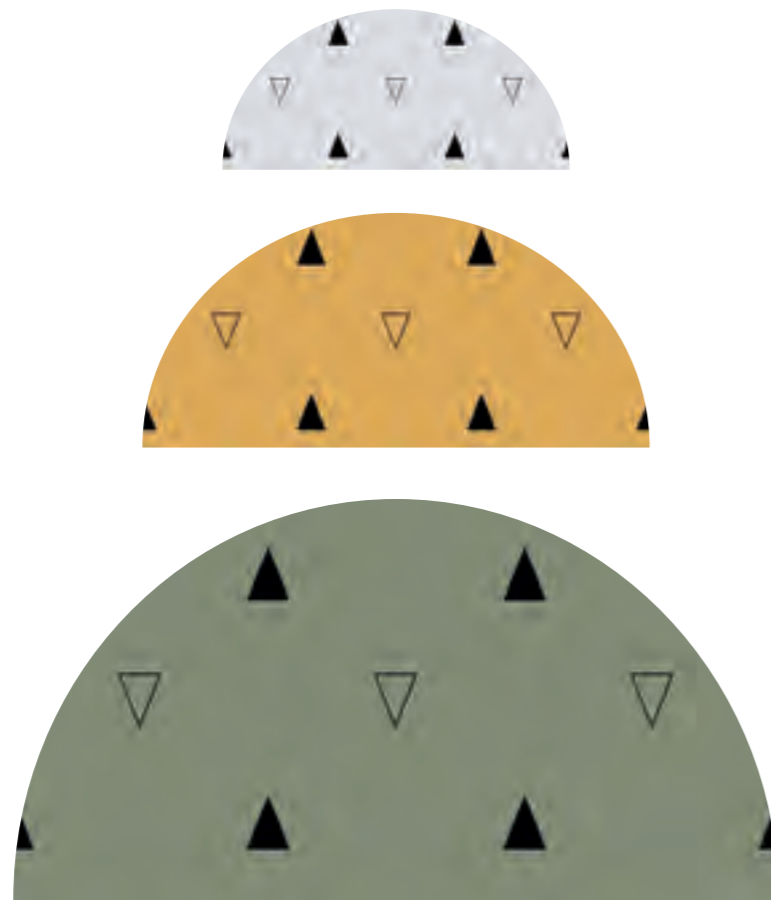







Colonna con scrittoio estraibile a scomparsa, completa di vano a giorno con mensola.  
Wardrobe with retractable pull-out desk, with an open compartment and shelf.



scorrevole



Castel-ponte lineare con meccanismo di ribaltamento rete.

*Linear bridge bunk bed with folding bed base mechanism.*



ribaltabile



Libreria a spalla con ante scorrevoli su binario in melaminico Tortora e Pepper.

*Sliding door bookcase on tracks in Tortora and Pepper melamine.*

La libreria assume una configurazione sempre diversa grazie all'utilizzo delle ante scorrevoli.

*You can always have a different configuration of the library with the sliding doors.*



scorrevole

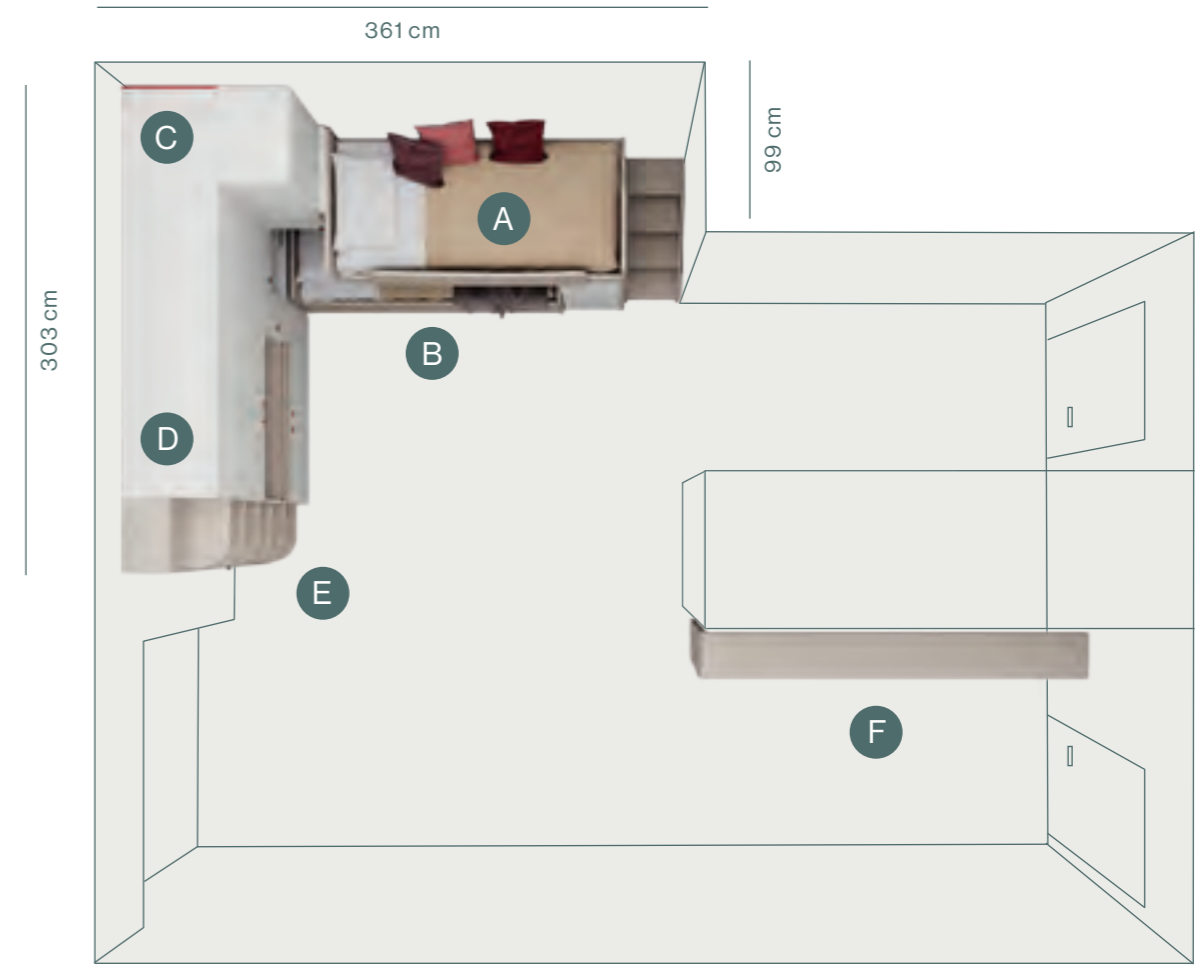
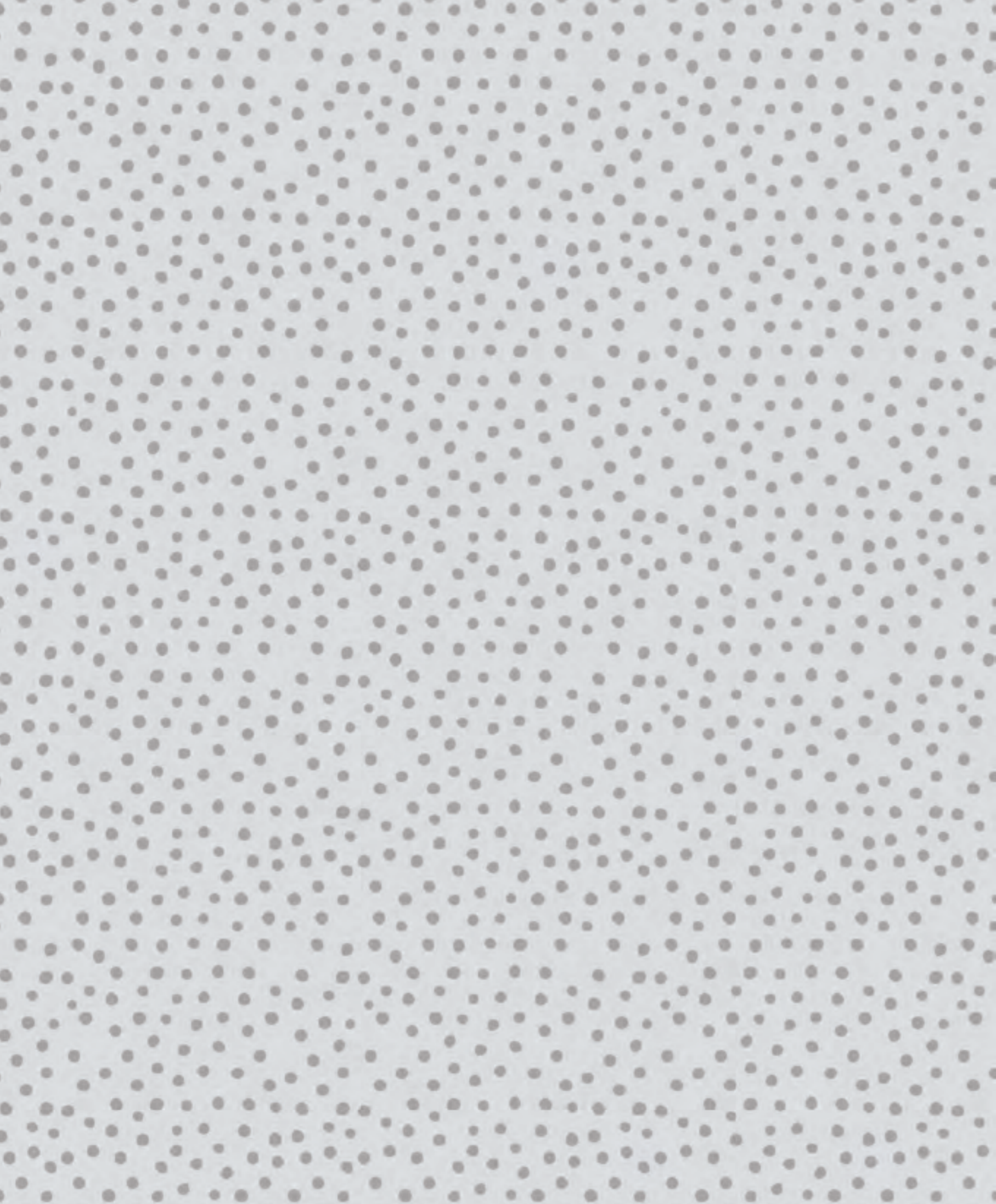

ambiente 13 mq



# 51

- A – Soppalco Zoom con rete da 90cm
- B – Divano letto Paf con rete estraibile
- C – Colonna Duplo
- D – Armadio con scrittoio estraibile
- E – Terminale armadio
- F – Libreria con ante scorrevoli



olmo sbiancato



tortora

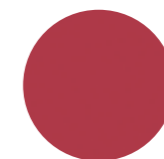

pepper





Il letto a castello con rete da 120cm traduce la comodità in una soluzione salvaspazio.

*The bunk bed with 120cm depth bed base translate comfort in a space-saving solution.*



Letto a castello profondo 129cm con fianco Quadro, protezione in metallo reclinabile e scaletta in metallo. Letto inferiore Flipper con rete da 120cm, giroletto e piede conico.

*Bunk bed in 129cm depth with Quadro side panel, Gate metal reclining protection and metal stepladder. Flipper low bed with 120cm bed base, bed frame and conical bed leg.*



Armadio battente con maniglia Gola e cabina Spot con mensole appendiabiti e porta camicie.  
*Hinged door with Gola handle and Spot walk-in closet with shelves, shirt units and hangers.*







Scrittoio Isola con cassetto e accessorio portaoggetti, sedia Ekipe su ruote.

Isola desks with drawer and wall unit, Ekipe chair on wheels.



285 cm  
ambiente 12.5 mq

# 52

- A – Letto castello Large con rete da 120cm
- B – Letto flipper con rete da 120cm
- C – Armadio con anta Filo1200
- D – Cabina Spot
- E – Scrittoio Isola, L135cm



ossidato

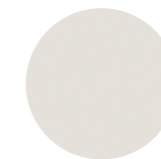

seta



beige



nuvola

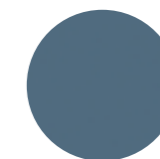

cobalto





Letto In-Out aperto, con camminata posteriore e letto Artiko Estraibile con cassettoni sotto.

*In-Out sliding bunk bed with back walk and Artiko Estraibile bed with drawers on tracks.*

Il letto In-Out si presta agli spazi più ridotti mantenendo due posti letto in una stanza.

*The In-Out bed is suitable for smaller spaces keeping two beds in one room.*



scorrevole



estraibile





Cabina angolo Van attrezzata internamente di ripiani, tubi appendi abiti e illuminazione, accostata a libreria terminale con scrittoio.

Van dressing closet equipped with shelves, hangers and lighting, with library terminal and suspended desk.



Basi a terra con cassetti in melaminico Grigio e Dalia, cuscino e schienale imbottiti per seduta e specchio.

*Chests of drawer in Grigio and Dalia melamine with pillows and mirror.*





Letto Artiko Estraibile su ruote in melaminico Dalia con cassettoni su guide.

Artiko Estraibile bed on wheels in Dalia melamine with drawers on tracks.

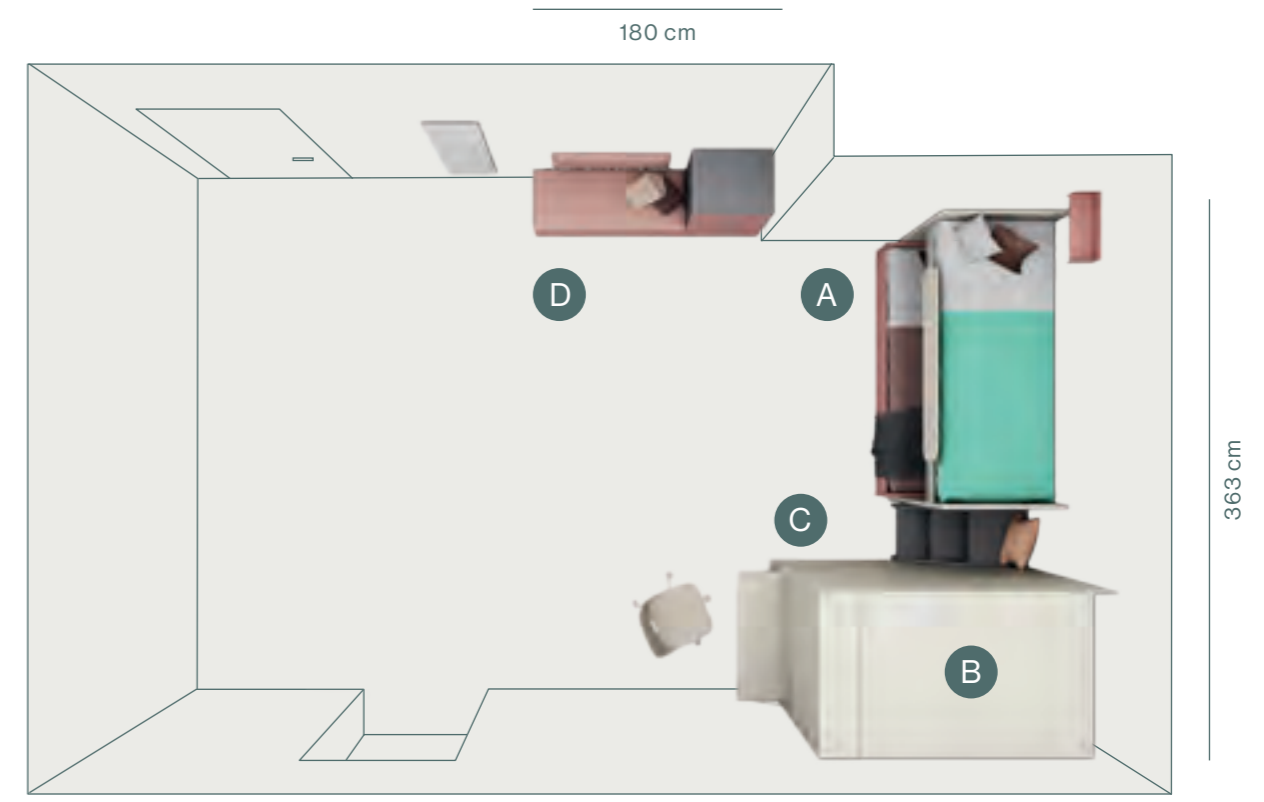

ambiente 12 mq

222 cm



# 53

- A – Castello scorrevole In-Out con rete da 80cm
- B – Cabina Van, tipo D
- C – Terminale libreria con scrittoio sospeso
- D – Cassettiere con cuscini e schienale imbottito



seta



dekor canapa

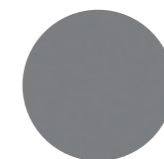

grigio

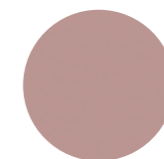

dalia

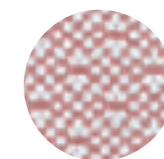

in&out S93

Carta da parati Bicycle  
*Bicycle Wallpaper*

Valorizzare le pareti con una decorazione  
illustrata, per chi ama il vintage.

*Enrich the walls with an illustrated decoration,  
for those who love vintage.*









## Cabina Flexi



**E1** Cabina Flexi  
lineare con ripiani, tubi  
appendiabiti e cassettiere a  
terra.

*Flexi walk-in*  
closet with shelves, hangers and  
chests of drawers.



**E2** Cabina Flexi  
ad angolo con ripiani, tubi  
appendiabiti e cassettiere a  
terra.

*Corner solution*  
of Flexi walk-in closet with  
shelves, hangers and chests  
of drawers.

## Cabina Flexi



La Cabina Flexi si sviluppa in qualsiasi ambiente come un armadio aperto con fianchi in profondità ridotta.

*The Flexi walk-in closet can be developed in every room like an opened wardrobe with reduced depth side panels.*



Armadiatura composta da armadi battenti con ante Pop e cabina Flexi con base cassetiera.

*Hinged wardrobe with Pop door and Flexi walk-in closet with a chest of drawer.*



Letto a castello a sbalzo con armadiatura attrezzata di cassetti, ripiani e tubi appendi abiti. Protezione in metallo reclinabile per letto a castello.

*Bunk bed with integrated wardrobe with drawers, shelves and hangers. Gate metal reclining protection for bunk bed.*

La protezione reclinabile Gate permette un accesso agevole alla rete superiore del letto a castello.

*Gate reclining protection allows an easy access to the upper bed base of the bunk bed.*



ribaltabile



Letto One in melaminico Olmo chiaro con cuffia imbottita in ecopelle Prestige E211, giroletto stondato e piedino laccato Salvia. Zona studio composta da libreria a spalla sospesa, scrittoio tipo 19 con gamba Greca e sedia Terry laccata su ruote.

*One bed in Olmo chiaro melamine with upholstered cover in ecopelle Prestige E211, bed frame with rounded edges and bed leg in Salvia lacquered finish. Study area made up of suspended bookcase, "19" desk with Greca leg and Terry lacquered chair on wheels.*

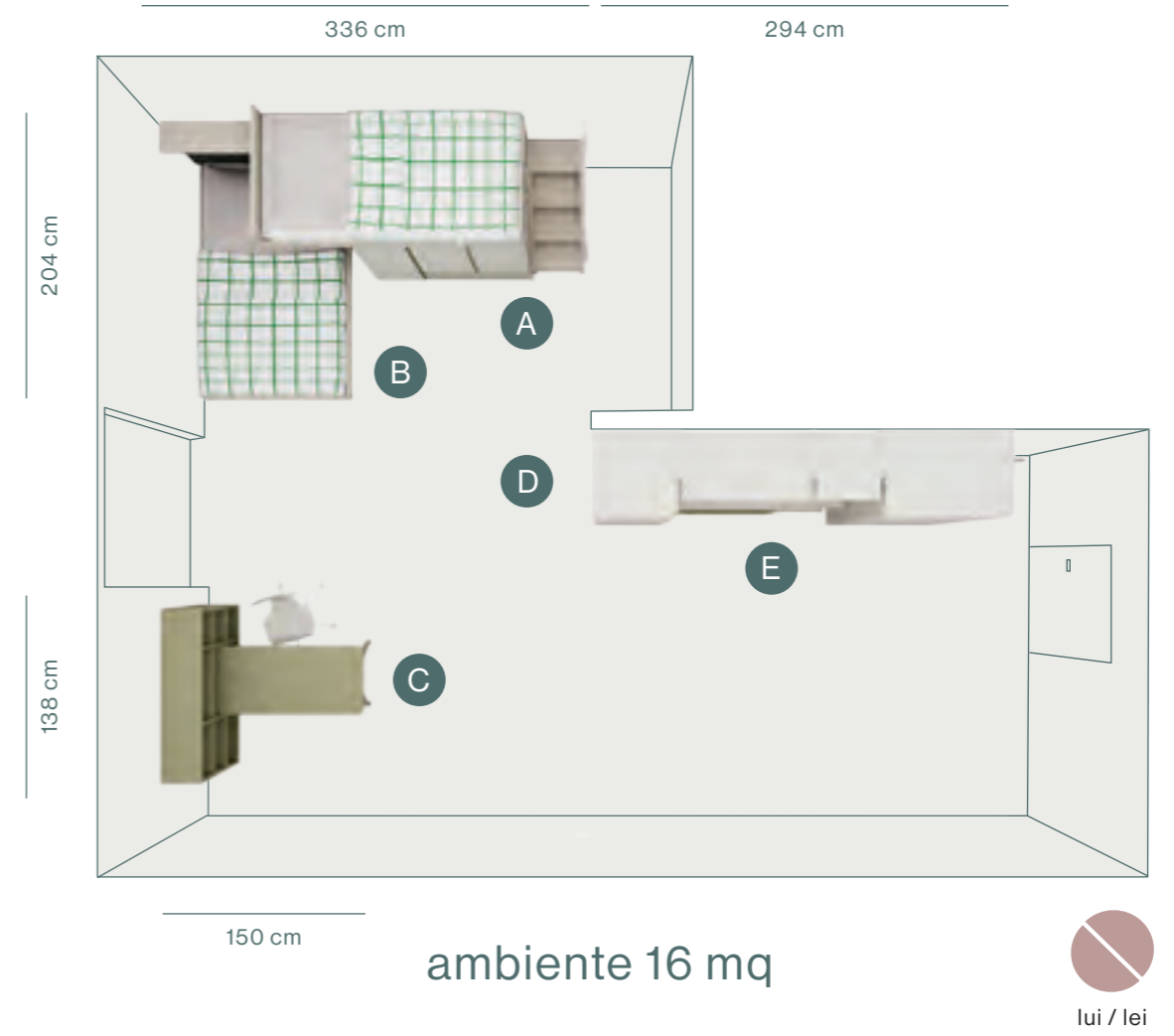

# 54

- A - Letto castello a sbalzo
- B - Letto One con cuffia
- C - Scrivitoio tipo 19, L150cm
- D - Armadio con anta Pop
- E - Cabina Flexi

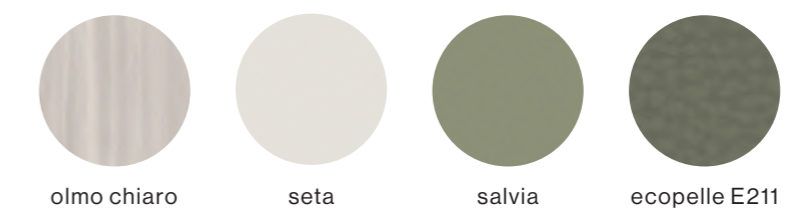





Zona studio composta da scrittoi tipo 50 in appoggio a cassetiera, gambe Fado, casellari Kaos, sedie Ekipe.

*Study zone made up of "50" desk over a chest of drawer, Fado legs, Kaos wall units, Ekipe chair on wheels.*





Letto Astron con testiera pannello e giroletto contenitore. Protezione Mouse reclinabile per letto a castello.

*Astron bed with panel headboard with 35cm high bed frame. Mouse bunk bed reclining protection in Platino melamine.*

## Letti a castello Zoom



**B1** Letto a castello Zoom  
con armadiatura composta da due ante intere, due ante ridotte e cassetti, con protezione Tablet.

*Zoom bunk bed*

*with wardrobe consisting of two doors, two reduced doors and drawers, with Tablet protection.*



**B2** Letto a castello Zoom  
con armadiatura composta da un'anta ridotta con due cassetti e scrittoio inserito, con protezione Mouse.

*Zoom bunk bed*

*with wardrobe consisting of one reduced door and two drawers, with inserted desk and Mouse protection.*



**B3** Letto a castello Zoom  
con due reti e cassettoni estraibili su ruote con protezione Derby.

*Zoom bunk bed*

*with two bed base and movable drawers on wheels with Derby protection.*



## Letti a castello Zoom



Il letto a castello Zoom è configurabile con armadiature, scrittoi e letti in funzione allo spazio disponibile.

*The Zoom bunk bed can be set up with wardrobe structures, desks and beds according to the space available.*





Cabina Be-Face attrezzata internamente di ripiani, cassettera e tubi appendi abiti.

*Be-face walk-in closet equipped with shelves, drawer, pacj and hangers.*

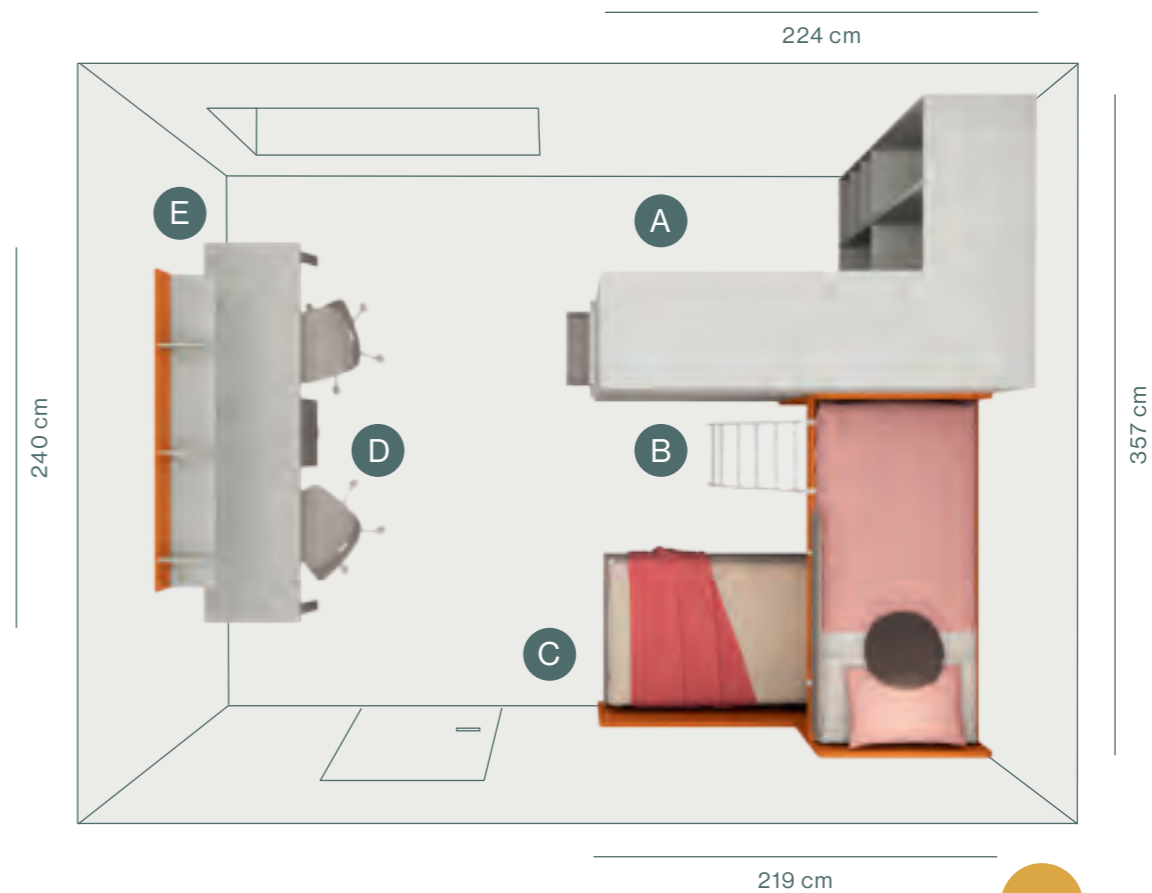

ambiente 14 mq



# 55

- A - Cabina Be-Face
- B - Letto a castello con scaletta in metallo
- C - Letto Astron con contenitore
- D - Due scrittoi tipo 50, L120cm
- E - Casellari Kaos

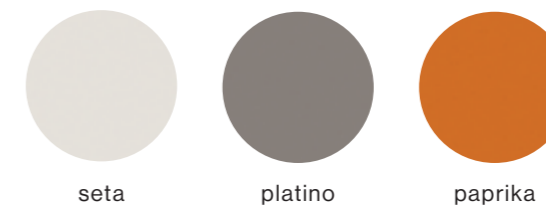



Letto Vagone 90 singolo con apertura sincro, affiancato da libreria a spalla e pensile con anta apertura vasistas.

*Vagone 90 single bed with syncro opening, next to a bookcase and wall unit with flap door.*





Armadio battente attrezzato internamene di divisorio con ripiani, cassetiera e cesto estraibile.

*Hinged wardrobe with T53 handle equipped with vertical partition with shelves, drawer pack and movable metal basket.*

I letti con meccanismo sono adattabili a tutta la modularità armadi e librerie per permettere un'integrazione perfetta nell'ambiente.

*The beds with mechanism are adaptable to all modular cabinets and bookcases to allow perfect integration into the environment.*



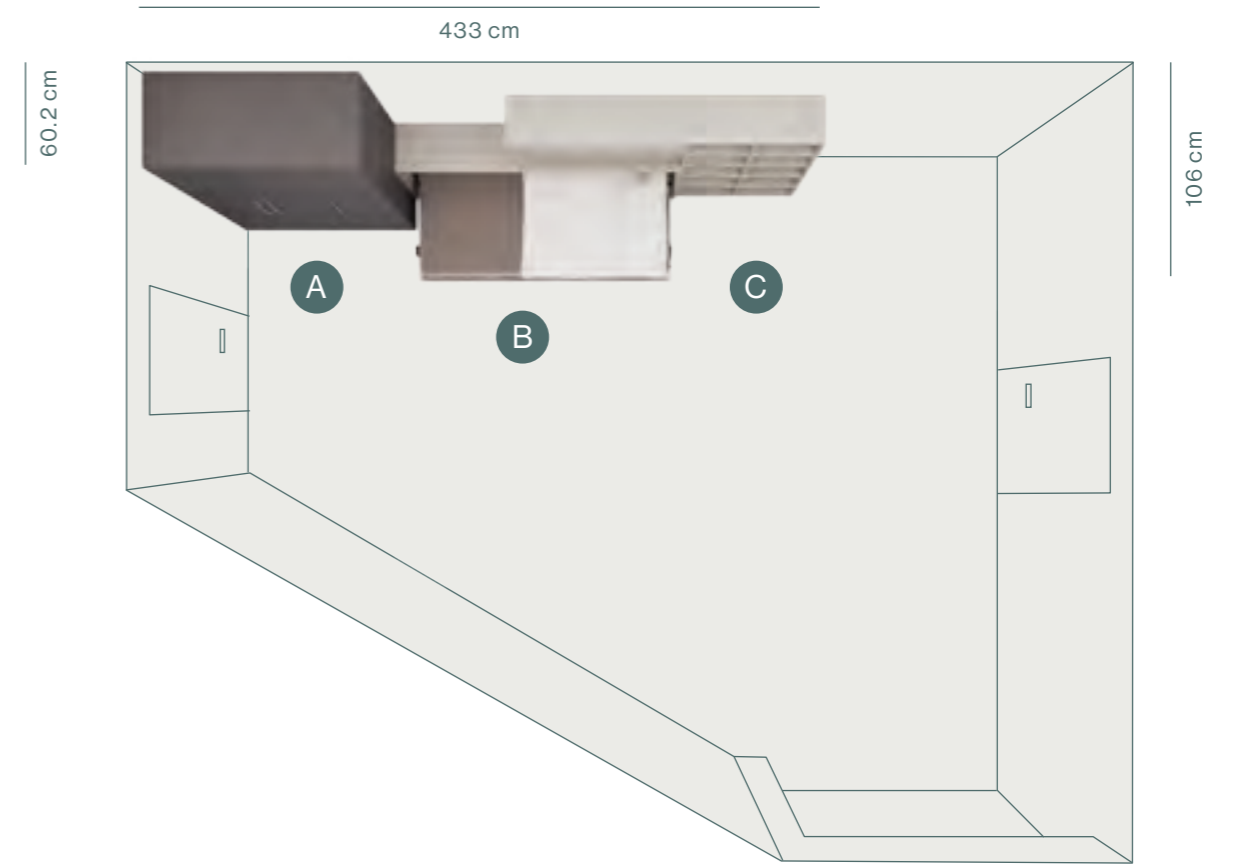

ambiente 8 mq



salvaspazio

# 56

- A – Armadio con ante battenti e maniglia T53
- B – Letto Vagone 90 con rete da 90cm
- C – Libreria a spalla

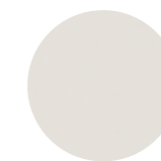

seta



dekor canapa



dekor bronzo

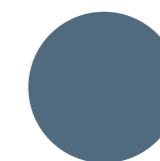

cobalto



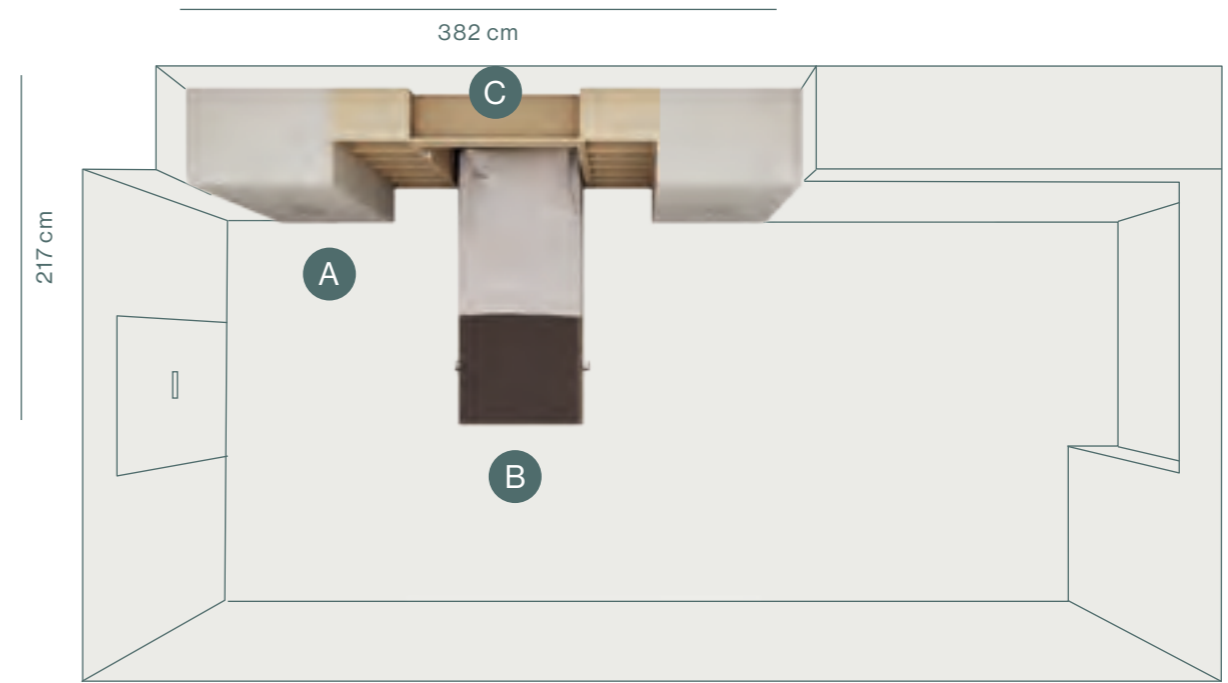

ambiente 12 mq



salvaspazio

# 57

- A – Armadio con anta battente e maniglia T53
- B – Letto Magic 90 con rete da 90cm
- C – Libreria a spalla



rovere

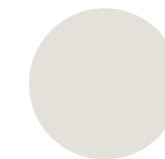

seta



petrolio

Letto Magic 90 affiancato da librerie a spalla e armadi con ante battenti.

*Magic 90 single bed next to bookcases and hinged wardrobe.*



### Melaminici base *Melamines*



Olmo sbiancato



Olmo chiaro



Ossidato



Rovere

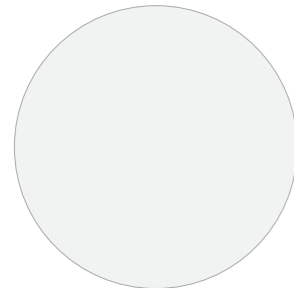

Bianco



Seta

### Melaminici dekor *Dekor melamines*



Dekor Canapa



Dekor Bronzo



Dekor Delavé



Dekor Greyge

### Melaminici colorati *Colored melamines*



Beige

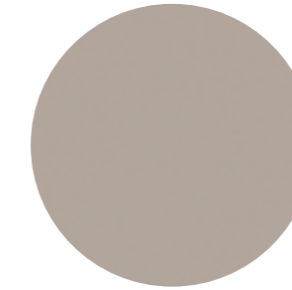

Tortora

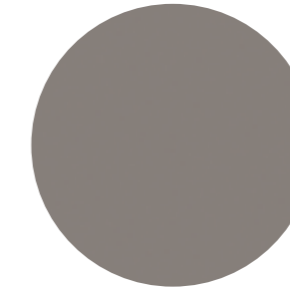

Platino

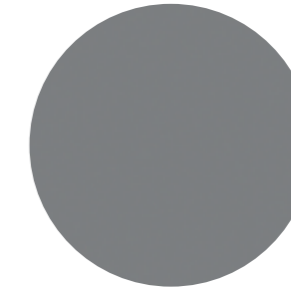

Grigio

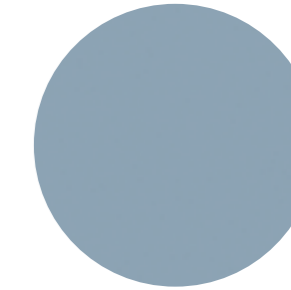

Nuvola

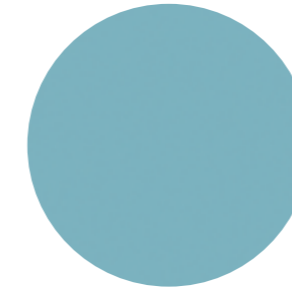

Cielo

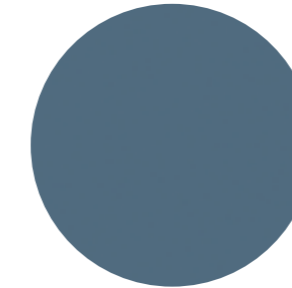

Cobalto

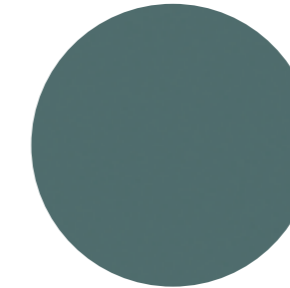

Petrolio

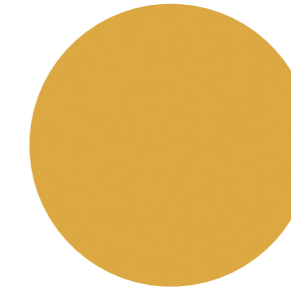

Curcuma

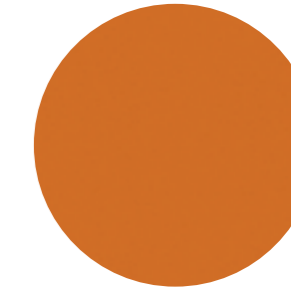

Paprika

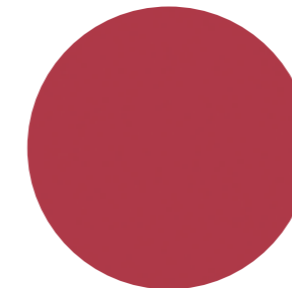

Pepper

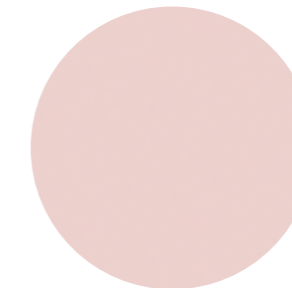

Confetto

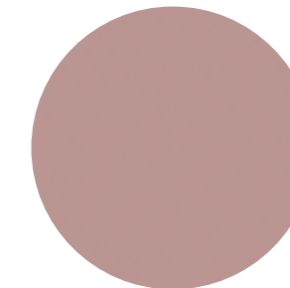

Dalia

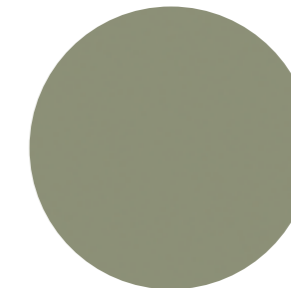

Salvia

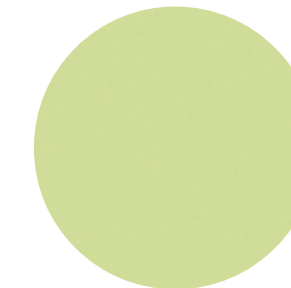

Menta

Tessuti  
Fabrics

In&Out Unito

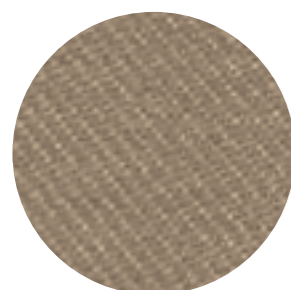

S070

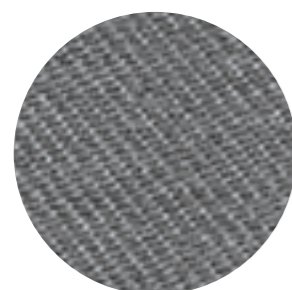

S074

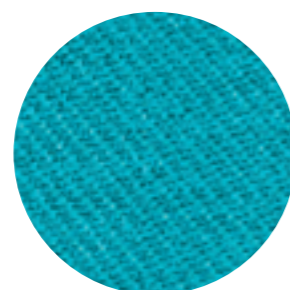

S076

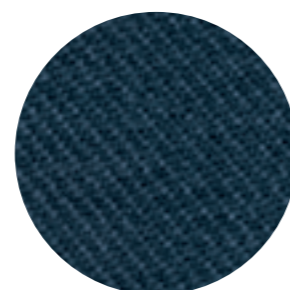

S072

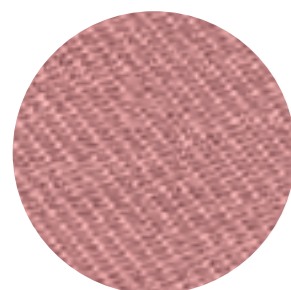

S073

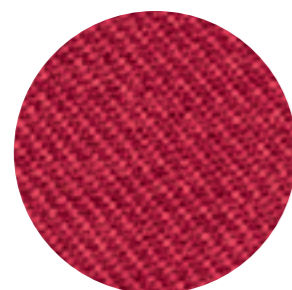

S075

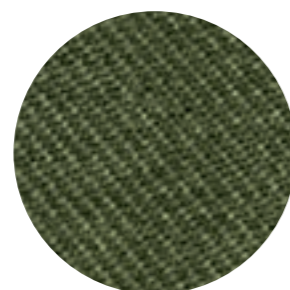

S071

In&Out Pois

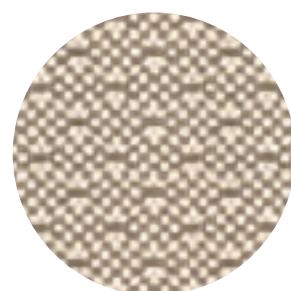

S090

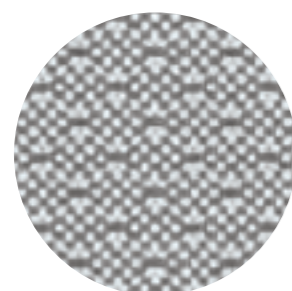

S094

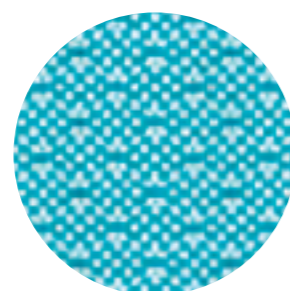

S096

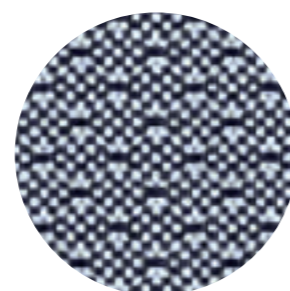

S092

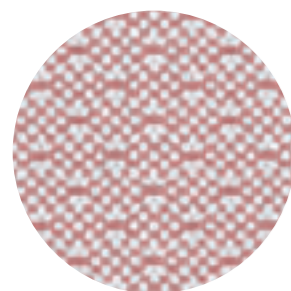

S093

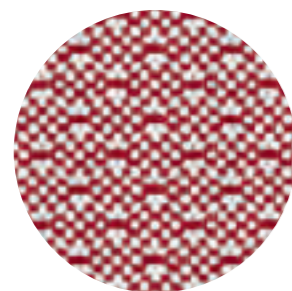

S095

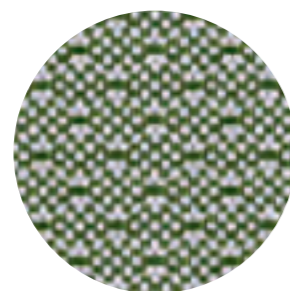

S091

Tessuti  
Fabrics

In&Out Chevron

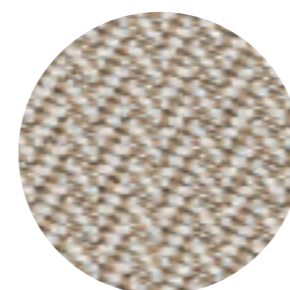

S121

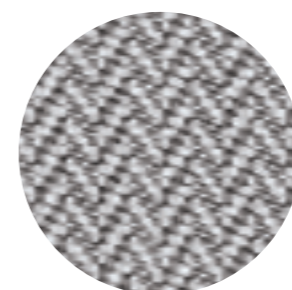

S122

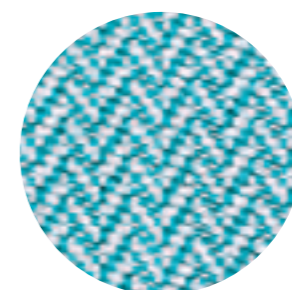

S124

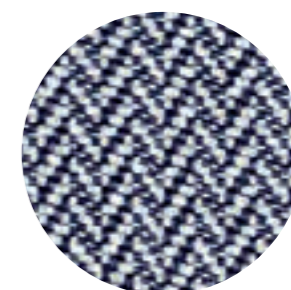

S123

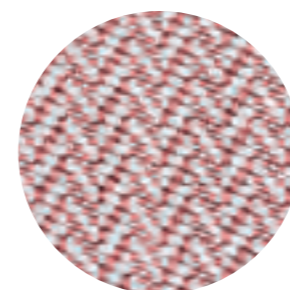

S126

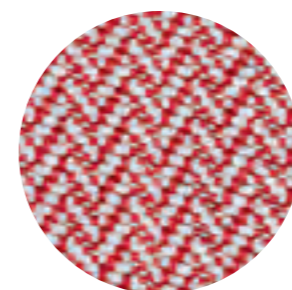

S120

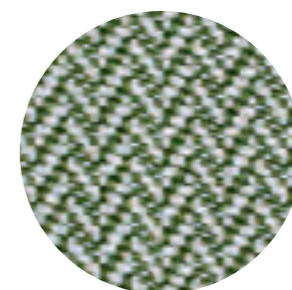

S125

Oregon

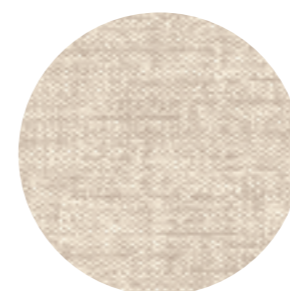

S030

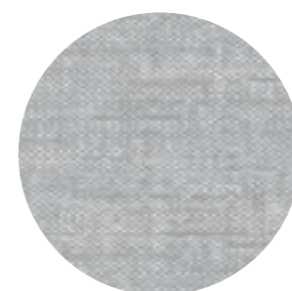

S031

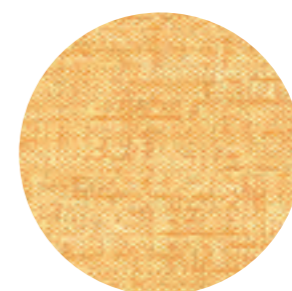

S042

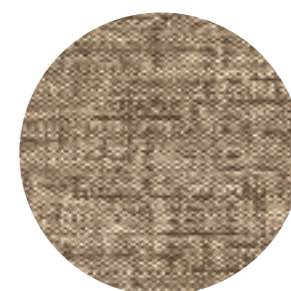

S033

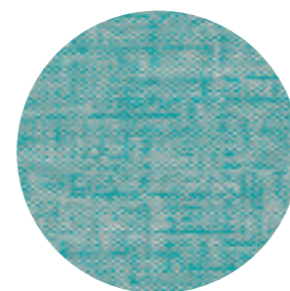

S043

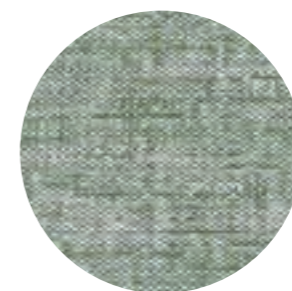

S035

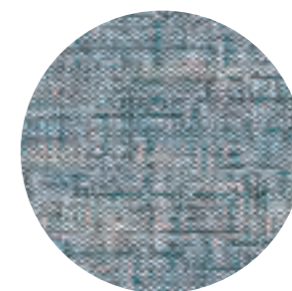

S036

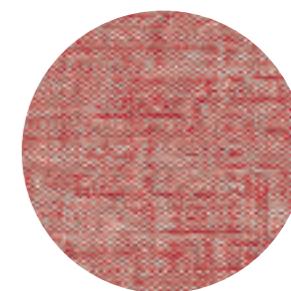

S037

Tessuti  
*Fabrics*

Ecopelle  
*Eco-leather*

Jam

Prestige



S150



S151

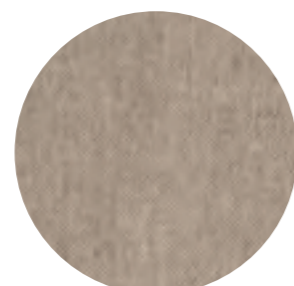

S152



S153



S154



E201



E202



E204

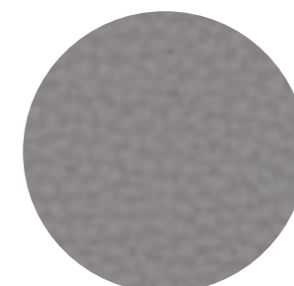

E205

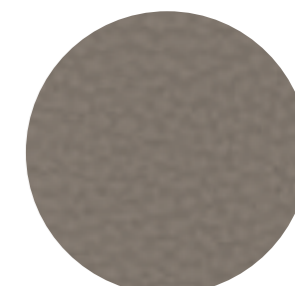

E207

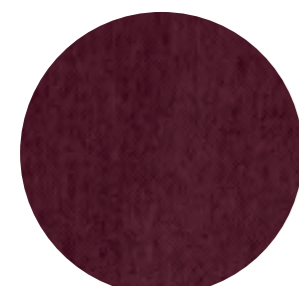

S155

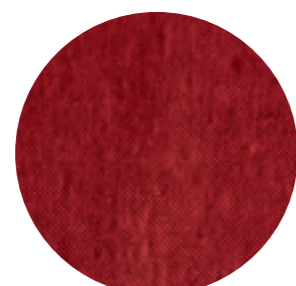

S156

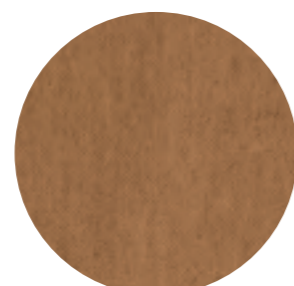

S157



S158

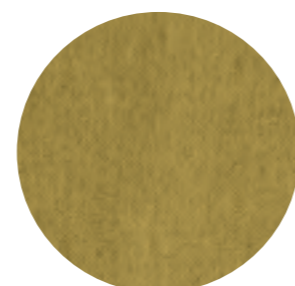

S159

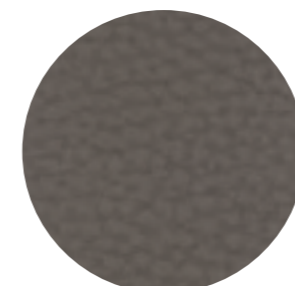

E208

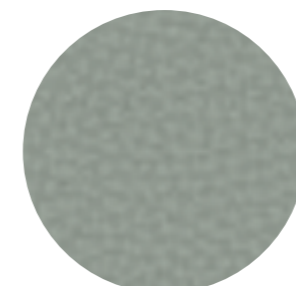

E209

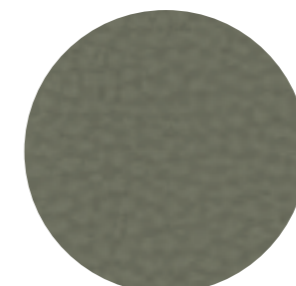

E211

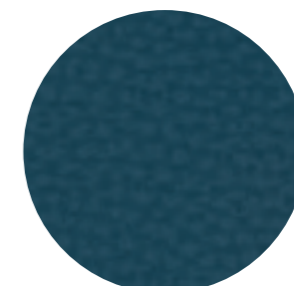

E213

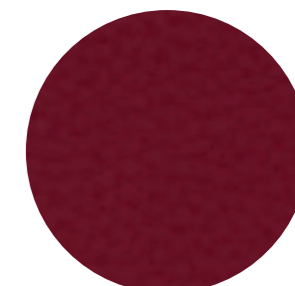

E215

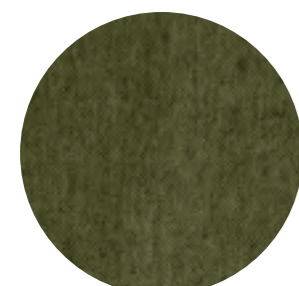

S160

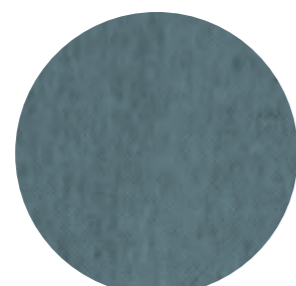

S161

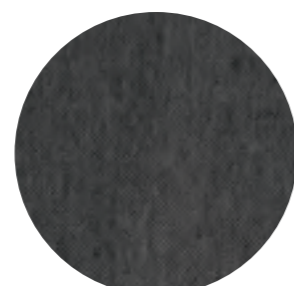

S162

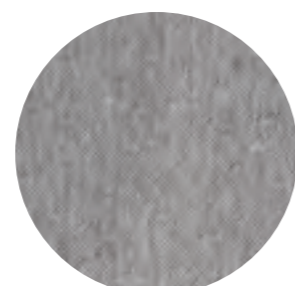

S163

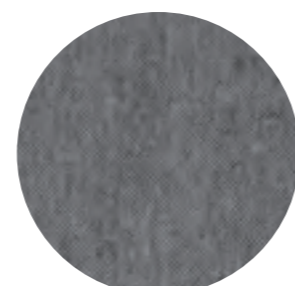

S164

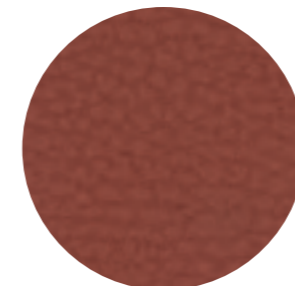

E216

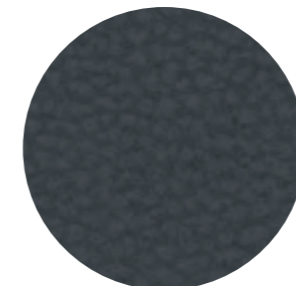

E220

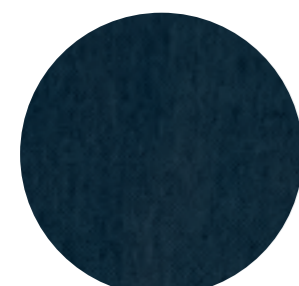

S165

# Maniglie Handles

# Maniglie Handles



T72 - T71



T95 - T91



T74 - T73



T93-T89



T31- T34



T77 - T76



T68 - T69



T40 - T42



T92 - T59



T 49 - T53



GOLA



T75



T84



T78



T36



T88



T37



T82



T79



T57

# Carta da parati Wallpaper

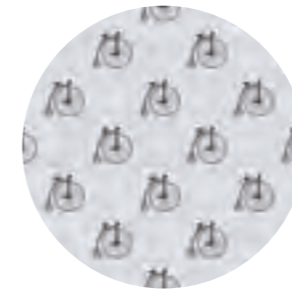

Bicycle - seta

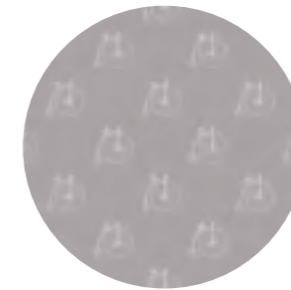

Bicycle - tortora

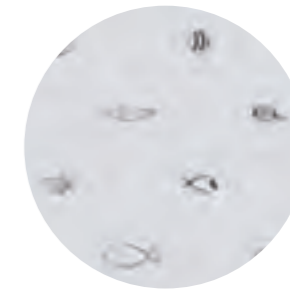

Fish - seta

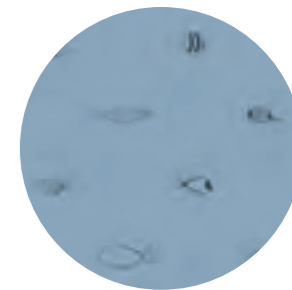

Fish - nuvola



Rondini - seta

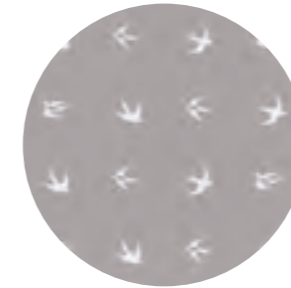

Rondini - tortora

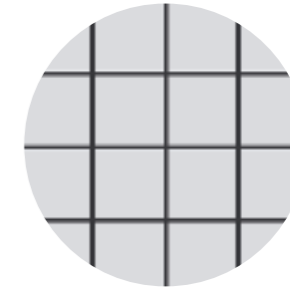

Grid - seta



Grid - petrolio

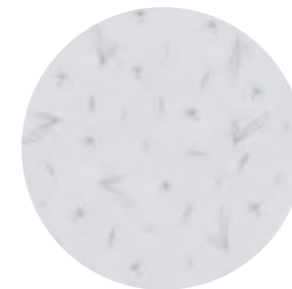

Leaf - seta



Leaf - tortora

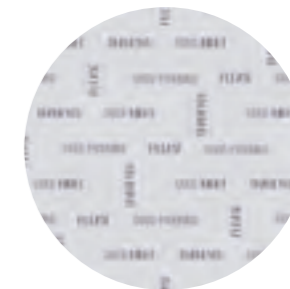

Education - seta

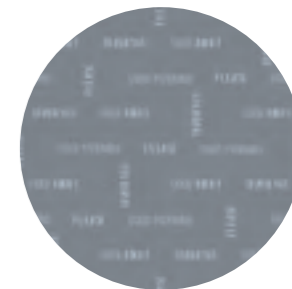

Education - grigio

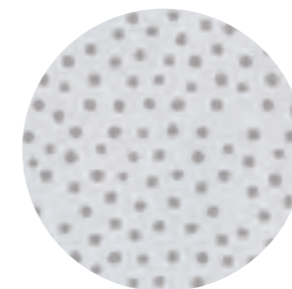

Pois - seta

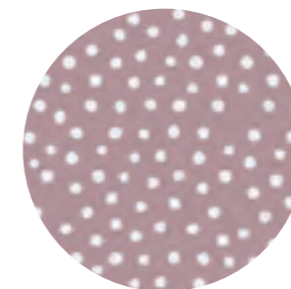

Pois - rosa



Cactus - seta

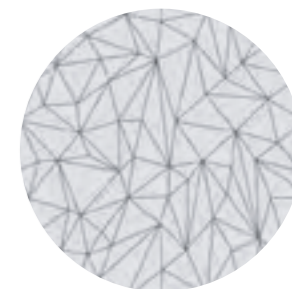

Line - seta

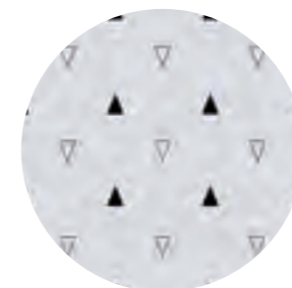

Triangles - seta

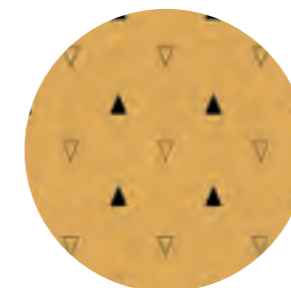

Triangles - ocra scuro

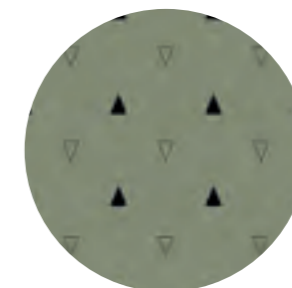

Triangles - salvia



## HOMES

AZIENDE DEL GRUPPO HOMES

**MISTRAL**  
**CLEVER**  
**NARDI INTERNI**  
**ORME**  
**SAN MICHELE**

## MISTRAL

MISTRAL  
Homes Casa s.p.a.  
via Ettore Majorana 186  
31053 Pieve di Soligo (TV)  
tel. +39 0438 839811  
fax +39 0438 839839  
e-mail: [mistral@homes.it](mailto:mistral@homes.it)  
[mistralcamerette.it](http://mistralcamerette.it)

EXPORT DEPARTMENT  
ph. +39 0438 839832  
fax + 39 0438 839859  
e-mail: [export@homes.it](mailto:export@homes.it)  
[www.homes.it](http://www.homes.it)

HOMES s.p.a.  
HEADQUARTERS  
via Montello, 63/1  
31053 Pieve di Soligo (TV) Italy  
tel. +39 0438 909081  
fax +39 0438 909089  
e-mail: [info@homes.it](mailto:info@homes.it)  
[www.homes.it](http://www.homes.it)

*Design: R&S HOMES*  
*Graphic Concept: Nicole Querini e Silvia Blazina*  
*Images: Neiko s.r.l.*  
*Fotolito: Luce Group*  
*Stampa: Imoco Group*

Marzo 2020 / 2800 copie

Mistral si riserva di apportare  
modifiche o migliorie in qualsiasi  
momento, anche senza preavviso.

Mistral is entitled to make  
modifications and improvements at  
any time, even without notice.



M2X00411

mistralcamerette.it

